

# Finishing Tools for Woodworking, Solid Surface and Composites

Innovative Solutions for the Kitchen & Bath and Furniture Industries





# Discover The Dynabrade Difference!

Established in 1969, **Dynabrade, Inc.** is recognized as the **global leader** in the design and manufacturing of high-quality **Portable Abrasive Power Tools**. Utilized in every corner of the world, **Dynabrade** tools continually meet and exceed the needs of countless industries, by offering **The Dynabrade Difference**:

- **“MADE IN USA” proudly displayed on every Industrial Air Tool!**
- **LIFETIME WARRANTY on Industrial Air Tools made in USA!**
- **SAME-DAY or NEXT-DAY Shipping on most USA Orders!**
- **FREE ON-SITE Demonstrations by Application EXPERTS!**
- **SYSTEMS Approach (Tools, Abrasives, Accessories) for Complete Solutions!**
- **All of the above, PLUS:**
  - Unmatched Marketing Materials
  - Personal, Professional Customer Service
  - Complete Service & Repair Program



**Dynabrade... The Global Leader in Abrasive Power Tool Technology!**



# Categorical Table of Contents

## Random Orbital Sanders

Dynorbital® Supreme Palm-Style Random Orbital Sanders .....	4 - 5
Dynorbital® Silver Supreme Palm-Style Random Orbital Sanders .....	6 - 7
Dynorbital-Spirit® Palm-Style Random Orbital Sanders .....	8 - 9
HiVac Dynorbital-Spirit® Random Orbital Sanders .....	10
Two-Hand Dynorbital® Random Orbital Sanders .....	11 - 12

## Gear-Driven Sanders

Two-Hand Gear-Driven Sanders.....	13
Large Diameter Gear-Driven Sanders .....	14
DynaLocke® Dual-Action Sander .....	15

## Dynabug® Orbital Finishing Sanders

Dynabug® Orbital Sanders .....	16
Dynabug® II Orbital Sanders.....	17 - 18
Dynabug® “Model T” Orbital Sanders .....	19 - 20

## Dynafine® Finishing Sanders

Dynafine® Detail Sander .....	21
Dynafine® Finger Sander, Raised Panel Sander, Dynascraper.....	22
“Backsplash” Sander .....	23

## In-Line Finishing Sanders

File Board Sander .....	23
Dynaline In-Line Sander.....	24

## Specialty Tools

Trim Routers .....	25 - 28
“Take-About” Sander, Electric Dynafine® II Abrasive Belt Tool .....	29

## Abrasive Star Sanders

Dyninger.....	30
Lightweight Dyninger .....	31

## Buffing Tools

Palm-Style Buffer, Angle-Head Buffer .....	32
7° Offset Buffers .....	33
Right Angle Buffer, Electric Buffer .....	34

## Source Capture Systems

Raptor Vac™ Portable Vacuum Systems.....	35 - 36
Downdraft Sanding Tables .....	36

## Accessories

General Pneumatic Tool Accessories.....	37 - 42
Sanding and Polishing Backup Pads.....	43 - 53
Pneumatic Tool Information .....	54 - 55



# Dynorbital® Supreme

## Air-Powered Random Orbital Sander

### Setting the Standard for Random Orbital Supremacy!

- The cornerstone of the “D3” Series, Dynorbital® Supreme sports a distinctive look, signifying many innovations and improvements!
- “D3” advancements include refined ergonomic design, increased vacuum capabilities, aggressive 3/8" (10 mm) orbit and more.
- When operating on work surface, tool maintains highest RPM in the industry!

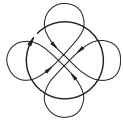

**3/8"**  
(10 mm)  
Dia. Orbit

For Aggressive Sanding  
(Orange Lever)

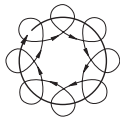

**3/16"**  
(5 mm)  
Dia. Orbit

For General Sanding  
(Silver Lever)



**3/32"**  
(2.5 mm)  
Dia. Orbit

For Ultra-Fine Sanding  
(Black Lever)

## Non-Vacuum

- Includes low profile, premium urethane weight-mated sanding pad.
- Optional vacuum conversion kits are available to easily convert non-vacuum tool to self-generated vacuum tool or central vacuum tool (see page 41).

Pad Diameter Inch (mm)	3/8" (10 mm) Orbit Models	3/16" (5 mm) Orbit Models	3/32" (2.5 mm) Orbit Models
3-1/2 (89)	56870	56800	56840
5 (127)	56880	56815*	56850
6 (152)	56890	56826**	56859

Tune-Up Kit: No. 96024

\*USA Government National Stock Number 5130013993588

\*\*USA Government National Stock Number 5130014066450



Model  
56815

See pages 43-44  
for Dynabrade  
High-Quality  
Sanding Pads!

## Self-Generated Vacuum

- Includes low profile, premium urethane weight-mated sanding pad.
- Ready for connection to optional portable self-contained dust collection system (see page 42).

Pad Diameter Inch (mm)	3/8" (10 mm) Orbit Models	3/16" (5 mm) Orbit Models	3/32" (2.5 mm) Orbit Models
3-1/2 (89)	56873	56803	56843
5 (127)	56883	56818*	56853
6 (152)	56893	56829**	56862

Tune-Up Kit: No. 96024

\*USA Government National Stock Number 5130012462258

\*\*USA Government National Stock Number 5130014677026



Model  
56818

Portable Dust Collection System  
(Optional - See Page 42)

## Central Vacuum

- Includes low profile, premium urethane weight-mated sanding pad.
- Has 1" (25 mm) dia. vacuum port for easy connection to central vacuum system.

Pad Diameter Inch (mm)	3/8" (10 mm) Orbit Models	3/16" (5 mm) Orbit Models	3/32" (2.5 mm) Orbit Models
3-1/2 (89)	56874	56804	56844
5 (127)	56884	56819	56854
6 (152)	56894	56830*	56863

Tune-Up Kit: No. 96024

\*USA Government National Stock Number 5130014125177



Model  
56819



# Dynorbital® Supreme



## Air-Powered Random Orbital Sander

The BEST Keeps Getting Better – Dynorbital® Supreme Offers “D3” Innovations!

### Refined Ergonomic Tool Grip

Allows more comfortable grip and feel, reducing operator fatigue and increasing efficiency.

### Auto-Recess Throttle Lever

Lever recesses into housing grip when depressed, eliminating pressure-point on operator’s palm. Lever is color-coded to identify tool orbit (see page 4).

### Comfort Platform

**U.S. Patent No. D610,428**

Provides additional hand and wrist support, enhancing operator comfort. Also offers protection against cold air exhaust.

### Perfectly Balanced Sanding Pad

**Ask for the ORANGE!**

Perfectly-balanced, weight-mated sanding pad with exclusive **single-piece hub design**. Dynabrade premium urethane pads offer smoother operating performance and minimal vibration.

**THREE Diameters:**

3-1/2" (89 mm) – 80 grams

5" (127 mm) – 100 grams

6" (152 mm) – 130 grams

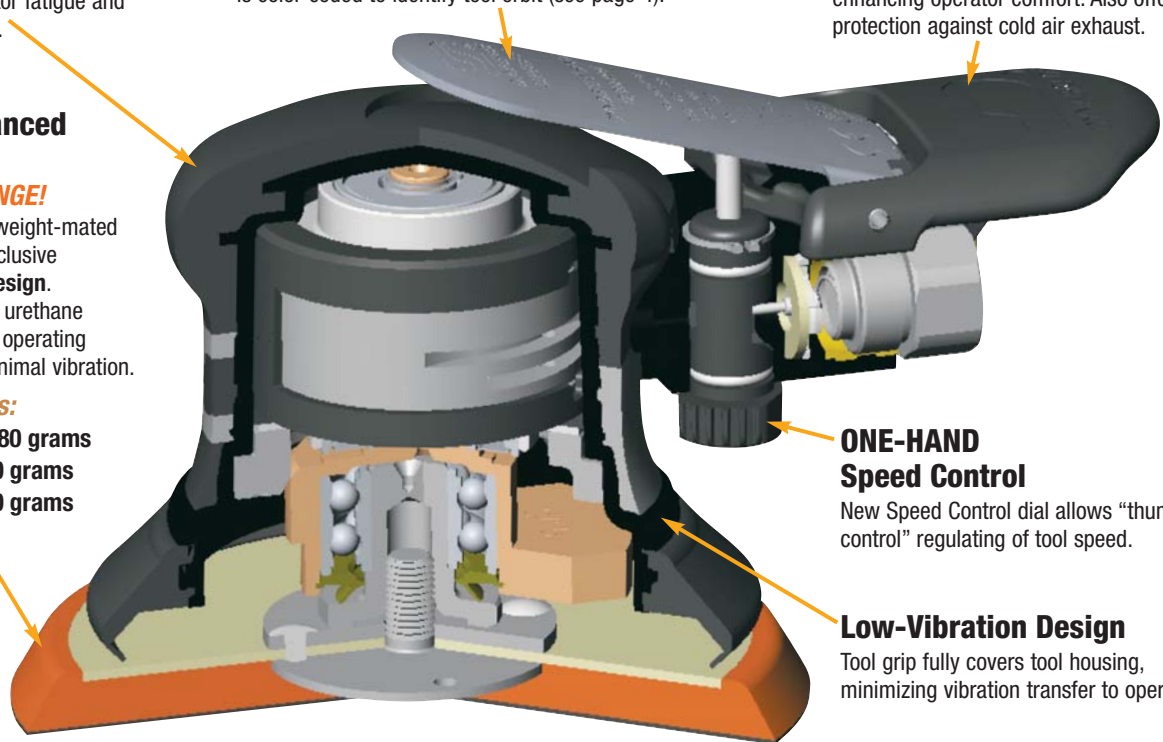

### ONE-HAND Speed Control

New Speed Control dial allows “thumb control” regulating of tool speed.

### Low-Vibration Design

Tool grip fully covers tool housing, minimizing vibration transfer to operator.

### Enhanced Vacuum Capabilities

Vacuum port diameter is increased by **110%**, allowing maximum capture of dust and debris!



Shroud included with all Dynorbital® Supreme, Dynorbital® Silver Supreme, and Dynorbital-Spirit® vacuum models.

## Dynorbital® Supreme Models

Model Number	Vacuum Style	Tool Dia. Inch (mm)	Dia. Orbit Inch (mm)	Sound Level	Weight Pound (kg)	Length Inch (mm)
56800	Non-Vac	3-1/2 (89)	3/16 (5)	77 dB(A)	2.1 (1)	6 (152)
56815	Non-Vac	5 (127)	3/16 (5)	80 dB(A)	2.1 (1)	6-1/2 (165)
56826	Non-Vac	6 (152)	3/16 (5)	78 dB(A)	2.2 (1)	7 (178)
56840	Non-Vac	3-1/2 (89)	3/32 (2.5)	76 dB(A)	2.1 (1)	6 (152)
56850	Non-Vac	5 (127)	3/32 (2.5)	77 dB(A)	2.1 (1)	6-1/2 (165)
56859	Non-Vac	6 (152)	3/32 (2.5)	76 dB(A)	2.2 (1)	7 (178)
56870	Non-Vac	3-1/2 (89)	3/8 (10)	80 dB(A)	2.2 (1)	6 (152)
56880	Non-Vac	5 (127)	3/8 (10)	78 dB(A)	2.3 (1)	6-1/2 (165)
56890	Non-Vac	6 (152)	3/8 (10)	80 dB(A)	2.4 (1)	7 (178)
56803	Self-Gen	3-1/2 (89)	3/16 (5)	84 dB(A)	2.1 (1)	8-1/4 (210)
56818	Self-Gen	5 (127)	3/16 (5)	82 dB(A)	2.1 (1)	8-1/2 (216)
56829	Self-Gen	6 (152)	3/16 (5)	85 dB(A)	2.3 (1)	9 (229)
56843	Self-Gen	3-1/2 (89)	3/32 (2.5)	81 dB(A)	2.1 (1)	8-1/4 (210)
56853	Self-Gen	5 (127)	3/32 (2.5)	83 dB(A)	2.1 (1)	8-1/2 (216)

Model Number	Vacuum Style	Tool Dia. Inch (mm)	Dia. Orbit Inch (mm)	Sound Level	Weight Pound (kg)	Length Inch (mm)
56862	Self-Gen	6 (152)	3/32 (2.5)	84 dB(A)	2.3 (1)	9 (229)
56873	Self-Gen	3-1/2 (89)	3/8 (10)	84 dB(A)	2.3 (1)	8-1/4 (210)
56883	Self-Gen	5 (127)	3/8 (10)	85 dB(A)	2.3 (1)	8-1/2 (216)
56893	Self-Gen	6 (152)	3/8 (10)	85 dB(A)	2.5 (1.1)	9 (229)
56804	Central	3-1/2 (89)	3/16 (5)	79 dB(A)	2.1 (1)	7 (178)
56819	Central	5 (127)	3/16 (5)	80 dB(A)	2.2 (1)	7-1/4 (184)
56830	Central	6 (152)	3/16 (5)	81 dB(A)	2.3 (1)	7-3/4 (197)
56844	Central	3-1/2 (89)	3/32 (2.5)	79 dB(A)	2.1 (1)	7 (178)
56854	Central	5 (127)	3/32 (2.5)	80 dB(A)	2.2 (1)	7-1/4 (184)
56863	Central	6 (152)	3/32 (2.5)	79 dB(A)	2.3 (1)	7-3/4 (197)
56874	Central	3-1/2 (89)	3/8 (10)	80 dB(A)	2.3 (1)	7 (178)
56884	Central	5 (127)	3/8 (10)	81 dB(A)	2.3 (1)	7-1/4 (184)
56894	Central	6 (152)	3/8 (10)	84 dB(A)	2.4 (1)	7-3/4 (197)

**Additional Specifications:** Motor .28 hp (209 W) • Motor 12,000 RPM • Pad Thread 5/16"-24 Male • Air Inlet Thread 1/4" NPT  
 Hose I.D. Size 1/4" (6 mm) • Air Flow Rate 18 SCFM/510 L/Min • Height 3-1/2" (89 mm) • Air Pressure 90 PSIG (6.2 Bar)  
 Sound Level is the pressure measurement according to the method outlined in ISO regulation ISO-15744

# Dynorbital® Silver Supreme

## Air-Powered Random Orbital Sander

### Supreme Power in Lightweight Package!

- The newest tool in our "D3" Series is the ultimate combination of Supreme power and lightweight comfort!
- "D3" innovations include all-steel components, compact Ergo Grip, outstanding vacuum capabilities and more.
- Steel cylinder and end plates stay perfectly aligned, maximizing motor performance!

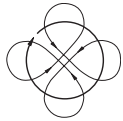

**3/8"**  
(10 mm)  
Dia. Orbit

For Aggressive Sanding  
(Orange Lever)

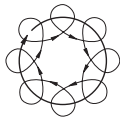

**3/16"**  
(5 mm)  
Dia. Orbit

For General Sanding  
(Silver Lever)



**3/32"**  
(2.5 mm)  
Dia. Orbit

For Ultra-Fine Sanding  
(Black Lever)

## Non-Vacuum

- Includes low profile, premium urethane weight-mated sanding pad.
- Optional vacuum conversion kits are available to easily convert non-vacuum tool to self-generated vacuum tool or central vacuum tool (see page 41).



WATCH Tool  
at Work!



See pages 43-44  
for Dynabrade  
High-Quality  
Sanding Pads!

Pad Diameter Inch (mm)	3/8" (10 mm) Orbit Models	3/16" (5 mm) Orbit Models	3/32" (2.5 mm) Orbit Models
3 (76)	69100	69105	69110
3-1/2 (89)	69000	69015	69030
5 (127)	69005	69020	69035
6 (152)	69010	69025	69040

Tune-Up Kit: No. 96620

## Self-Generated Vacuum

- Includes low profile, premium urethane weight-mated sanding pad.
- Ready for connection to optional portable self-contained dust collection system (see page 42).



Portable Dust Collection System  
(Optional - See Page 42)

Pad Diameter Inch (mm)	3/8" (10 mm) Orbit Models	3/16" (5 mm) Orbit Models	3/32" (2.5 mm) Orbit Models
3 (76)	69103	69108	69113
3-1/2 (89)	69003	69018	69033
5 (127)	69008	69023	69038
6 (152)	69013	69028	69043

Tune-Up Kit: No. 96620

## Central Vacuum

- Includes low profile, premium urethane weight-mated sanding pad.
- Has 1" (25 mm) dia. vacuum port for easy connection to central vacuum system.



Model  
69024

Pad Diameter Inch (mm)	3/8" (10 mm) Orbit Models	3/16" (5 mm) Orbit Models	3/32" (2.5 mm) Orbit Models
3 (76)	69104	69109	69114
3-1/2 (89)	69004	69019	69034
5 (127)	69009	69024	69039
6 (152)	69014	69029	69044

Tune-Up Kit: No. 96620



# Dynorbital® Silver Supreme



## Air-Powered Random Orbital Sander

*Combines Supreme Power with Lightweight Comfort!*

### Auto-Recess Throttle Lever

Lever recesses into housing grip when depressed, eliminating pressure-point on operator's palm. Lever is made from composite material to insulate against cold air. Lever is color-coded to identify tool orbit (see page 6).

### Comfort Platform

**U.S. Patent No. D610,428**

Provides additional hand and wrist support, enhancing operator comfort. Also offers protection against cold air exhaust.

### Compact Grip Size

Compact, ergonomic design is ideal for operators with smaller hands.

### Steel Cylinder and End Plates

Steel cylinder and end plates stay perfectly aligned. Design of end plates keeps more air in cylinder, increasing motor efficiency!

### Single-Piece Locking Ring

Allows easier assembly and provides tighter seal.

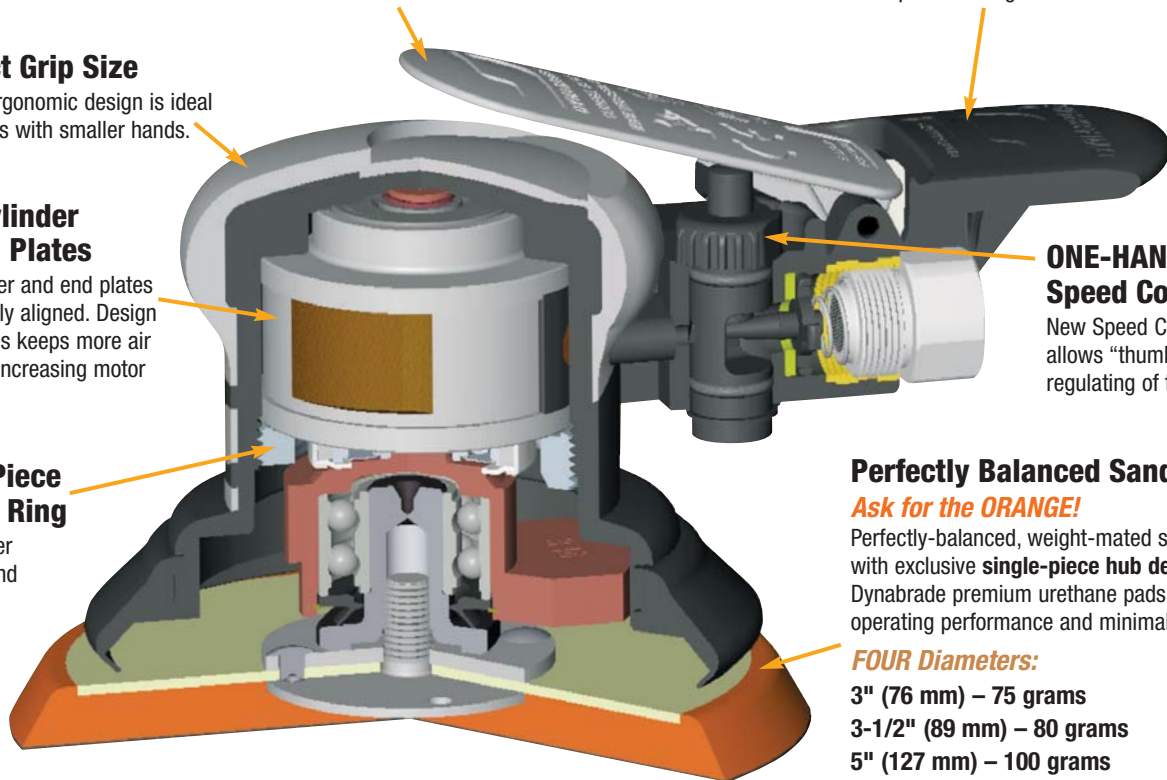

### ONE-HAND Speed Control

New Speed Control dial allows "thumb control" regulating of tool speed.

### Perfectly Balanced Sanding Pad

**Ask for the ORANGE!**

Perfectly-balanced, weight-mated sanding pad with exclusive **single-piece hub design**. Dynabrade premium urethane pads offer smoother operating performance and minimal vibration.

**FOUR Diameters:**

**3" (76 mm) – 75 grams**

**3-1/2" (89 mm) – 80 grams**

**5" (127 mm) – 100 grams**

**6" (152 mm) – 130 grams**

## Dynorbital® Silver Supreme Models

Model Number	Vacuum Style	Tool Dia. Inch (mm)	Dia. Orbit Inch (mm)	Sound Level	Weight Pound (kg)	Length Inch (mm)
69000	Non-Vac	3-1/2 (89)	3/8 (10)	76 dB(A)	1.8 (.8)	6 (152)
69005	Non-Vac	5 (127)	3/8 (10)	80 dB(A)	1.9 (.9)	6-1/2 (165)
69010	Non-Vac	6 (152)	3/8 (10)	83 dB(A)	1.9 (.9)	7 (178)
69015	Non-Vac	3-1/2 (89)	3/16 (5)	77 dB(A)	1.7 (.8)	6 (152)
69020	Non-Vac	5 (127)	3/16 (5)	77 dB(A)	1.8 (.8)	6-1/2 (165)
69025	Non-Vac	6 (152)	3/16 (5)	77 dB(A)	1.8 (.8)	7 (178)
69030	Non-Vac	3-1/2 (89)	3/32 (2.5)	75 dB(A)	1.7 (.8)	6 (152)
69035	Non-Vac	5 (127)	3/32 (2.5)	78 dB(A)	1.7 (.8)	6-1/2 (165)
69040	Non-Vac	6 (152)	3/32 (2.5)	78 dB(A)	1.8 (.8)	7 (178)
69100	Non-Vac	3 (76)	3/8 (10)	80 dB(A)	1.8 (.8)	6 (152)
69105	Non-Vac	3 (76)	3/16 (5)	80 dB(A)	1.7 (.8)	6-1/2 (165)
69110	Non-Vac	3 (76)	3/32 (2.5)	80 dB(A)	1.7 (.8)	7 (178)
69003	Self-Gen	3-1/2 (89)	3/8 (10)	84 dB(A)	1.9 (.9)	8-1/2 (216)
69008	Self-Gen	5 (127)	3/8 (10)	80 dB(A)	2.0 (.9)	8-1/2 (216)
69013	Self-Gen	6 (152)	3/8 (10)	80 dB(A)	2.1 (.9)	9 (229)
69018	Self-Gen	3-1/2 (89)	3/16 (5)	79 dB(A)	1.8 (.8)	8-1/2 (216)
69023	Self-Gen	5 (127)	3/16 (5)	81 dB(A)	1.9 (.9)	8-1/2 (216)
69028	Self-Gen	6 (152)	3/16 (5)	84 dB(A)	2.0 (.9)	9 (229)

Model Number	Vacuum Style	Tool Dia. Inch (mm)	Dia. Orbit Inch (mm)	Sound Level	Weight Pound (kg)	Length Inch (mm)
69033	Self-Gen	3-1/2 (89)	3/32 (2.5)	84 dB(A)	1.8 (.8)	8-1/2 (216)
69038	Self-Gen	5 (127)	3/32 (2.5)	84 dB(A)	1.9 (.9)	8-1/2 (216)
69043	Self-Gen	6 (152)	3/32 (2.5)	81 dB(A)	2.0 (.9)	9 (229)
69103	Self-Gen	3 (76)	3/8 (10)	81 dB(A)	1.9 (.9)	8-1/2 (216)
69108	Self-Gen	3 (76)	3/16 (5)	79 dB(A)	1.8 (.8)	8-1/2 (216)
69113	Self-Gen	3 (76)	3/32 (2.5)	83 dB(A)	1.8 (.8)	9 (229)
69004	Central	3-1/2 (89)	3/8 (10)	79 dB(A)	1.9 (.9)	7 (178)
69009	Central	5 (127)	3/8 (10)	80 dB(A)	2.0 (.9)	7-1/4 (184)
69014	Central	6 (152)	3/8 (10)	84 dB(A)	1.9 (.9)	7-3/4 (197)
69019	Central	3-1/2 (89)	3/16 (5)	83 dB(A)	1.8 (.8)	7 (178)
69024	Central	5 (127)	3/16 (5)	79 dB(A)	1.9 (.9)	7-1/4 (184)
69029	Central	6 (152)	3/16 (5)	83 dB(A)	2.0 (.9)	7-3/4 (197)
69034	Central	3-1/2 (89)	3/32 (2.5)	82 dB(A)	1.8 (.8)	7 (178)
69039	Central	5 (127)	3/32 (2.5)	81 dB(A)	1.8 (.8)	7-1/4 (184)
69044	Central	6 (152)	3/32 (2.5)	82 dB(A)	2.0 (.9)	7-3/4 (197)
69104	Central	3 (76)	3/8 (10)	82 dB(A)	1.9 (.9)	7 (178)
69109	Central	3 (76)	3/16 (5)	80 dB(A)	1.8 (.8)	7-1/4 (184)
69114	Central	3 (76)	3/32 (2.5)	82 dB(A)	1.8 (.8)	7-3/4 (197)

**Additional Specifications:** Motor .26 hp (194 W) • Motor 12,000 RPM • Pad Thread 5/16"-24 Male • Air Inlet Thread 1/4" NPT  
 Hose I.D. Size 1/4" (6 mm) • Air Flow Rate 16 SCFM/450 L/Min • Height 3-1/2" (89 mm) • Air Pressure 90 PSIG (6.2 Bar)  
 Sound Level is the pressure measurement according to the method outlined in ISO regulation ISO-15744

# Dynorbital-Spirit®

## Air-Powered Random Orbital Sander

### Lightweight Sander with "D3" Advantages

- Dynabrade's lightest Random Orbital Sander is ideal for vertical and contoured applications, and for operators with smaller hands.
- "D3" improvements include distinctive look, ergonomic tool grip for added comfort, increased vacuum efficiency and new muffler design.
- For light-to-medium duty customers who demand the Dynabrade Difference!

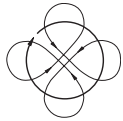

**3/8"**  
(10 mm)  
Dia. Orbit

For Aggressive Sanding  
(Orange Lever)

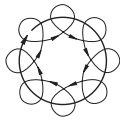

**3/16"**  
(5 mm)  
Dia. Orbit

For General Sanding  
(Silver Lever)



**3/32"**  
(2.5 mm)  
Dia. Orbit

For Ultra-Fine Sanding  
(Black Lever)



### Non-Vacuum

- Includes low profile, premium urethane weight-mated sanding pad.
- Optional vacuum conversion kits are available to easily convert non-vacuum tool to self-generated vacuum tool or central vacuum tool (see page 41).

Pad Diameter Inch (mm)	3/8" (10 mm) Orbit Models	3/16" (5 mm) Orbit Models	3/32" (2.5 mm) Orbit Models
3 (76)	59100	59105	59110
3-1/2 (89)	59000	59015	59030
5 (127)	59005	59020	59035
6 (152)	59010	59025*	59040

Tune-Up Kit: No. 96510

\*USA Government National Stock Number 5130015162219



Model  
59020

See pages 43-44  
for Dynabrade  
High-Quality  
Sanding Pads!

### Self-Generated Vacuum

- Includes low profile, premium urethane weight-mated sanding pad.
- Ready for connection to optional portable self-contained dust collection system (see page 42).

Pad Diameter Inch (mm)	3/8" (10 mm) Orbit Models	3/16" (5 mm) Orbit Models	3/32" (2.5 mm) Orbit Models
3 (76)	59103	59108	59113
3-1/2 (89)	59003	59018	59033
5 (127)	59008	59023/58054*	59038
6 (152)	59013	59028	59043

Tune-Up Kit: No. 96510

\*Model 58054 includes 56320 Hook-Face Pad with 44 holes (see page 44).



Model  
59023

Portable Dust Collection System  
(Optional - See Page 42)

### Central Vacuum

- Includes low profile, premium urethane weight-mated sanding pad.
- Has 1" (25 mm) dia. vacuum port for easy connection to central vacuum system.

Pad Diameter Inch (mm)	3/8" (10 mm) Orbit Models	3/16" (5 mm) Orbit Models	3/32" (2.5 mm) Orbit Models
3 (76)	59104	59109	59114
3-1/2 (89)	59004	59019	59034
5 (127)	59009	59024	59039
6 (152)	59014	59029*	59044

Tune-Up Kit: No. 96510



Model  
59024



# Dynorbital-Spirit®

## Air-Powered Random Orbital Sander



### Lightweight Random Orbital Sander Offers "D3" Advantages!

#### Auto-Recess Throttle Lever

Lever recesses into housing grip when depressed, eliminating pressure-point on operator's palm. Lever is made from composite material to insulate against cold air. Lever is color-coded to identify tool orbit (see page 8).

#### Comfort Platform

**U.S. Patent No. D610,428**

Provides additional hand and wrist support, enhancing operator comfort. Also offers protection against cold air exhaust.

#### Compact Grip Size

Compact, ergonomic design has been reduced in size by 5%. Ideal for operators with smaller hands, and use in vertical applications!

#### Single-Piece Locking Ring

Allows easier assembly and provides tighter seal.

#### ONE-HAND Speed Control

New Speed Control dial allows "thumb control" regulating of tool speed.

#### Perfectly Balanced Sanding Pad

**Ask for the ORANGE!**

Perfectly-balanced, weight-mated sanding pad with exclusive **single-piece hub design**. Dynabrade premium urethane pads offer smoother operating performance and minimal vibration.

**FOUR Diameters:**

**3" (76 mm) – 75 grams**

**3-1/2" (89 mm) – 80 grams**

**5" (127 mm) – 100 grams**

**6" (152 mm) – 130 grams**

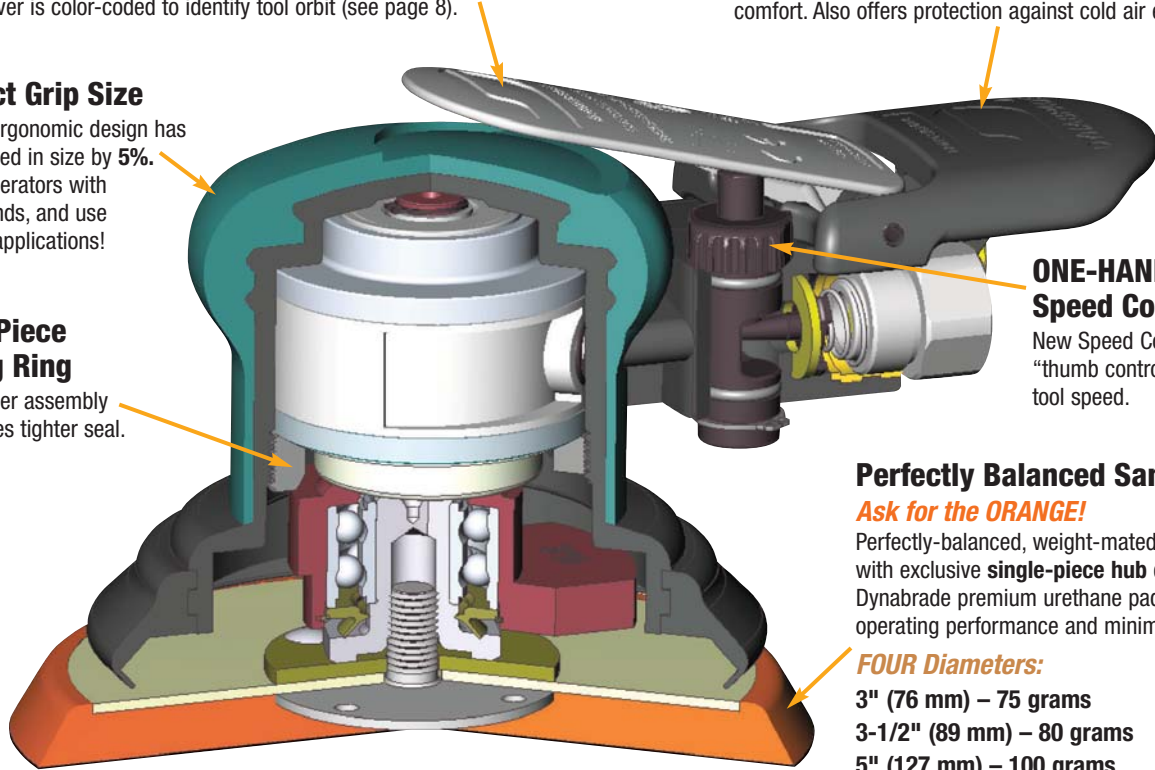

## Dynorbital-Spirit® Models

Model Number	Vacuum Style	Tool Dia. Inch (mm)	Dia. Orbit Inch (mm)	Sound Level	Weight Pound (kg)	Length Inch (mm)
59000	Non-Vac	3-1/2 (89)	3/8 (10)	81 dB(A)	1.4 (.6)	6 (152)
59005	Non-Vac	5 (127)	3/8 (10)	81 dB(A)	1.5 (.7)	6-1/2 (165)
59010	Non-Vac	6 (152)	3/8 (10)	82 dB(A)	1.6 (.7)	7 (178)
59015	Non-Vac	3-1/2 (89)	3/16 (5)	80 dB(A)	1.4 (.6)	6 (152)
59020	Non-Vac	5 (127)	3/16 (5)	80 dB(A)	1.4 (.6)	6-1/2 (165)
59025	Non-Vac	6 (152)	3/16 (5)	81 dB(A)	1.5 (.7)	7 (178)
59030	Non-Vac	3-1/2 (89)	3/32 (2.5)	81 dB(A)	1.4 (.6)	6 (152)
59035	Non-Vac	5 (127)	3/32 (2.5)	81 dB(A)	1.4 (.6)	6-1/2 (165)
59040	Non-Vac	6 (152)	3/32 (2.5)	82 dB(A)	1.5 (.6)	7 (178)
59100	Non-Vac	3 (76)	3/8 (10)	79 dB(A)	1.4 (.6)	6 (152)
59105	Non-Vac	3 (76)	3/16 (5)	79 dB(A)	1.4 (.6)	6-1/2 (165)
59110	Non-Vac	3 (76)	3/32 (2.5)	81 dB(A)	1.3 (.6)	7 (178)
59003	Self-Gen	3-1/2 (89)	3/8 (10)	82 dB(A)	1.5 (.7)	8-1/2 (216)
59008	Self-Gen	5 (127)	3/8 (10)	82 dB(A)	1.6 (.7)	8-1/2 (216)
59013	Self-Gen	6 (152)	3/8 (10)	85 dB(A)	1.7 (.7)	9 (229)
59018	Self-Gen	3-1/2 (89)	3/16 (5)	85 dB(A)	1.4 (.6)	8-1/2 (216)
59023/58054	Self-Gen	5 (127)	3/16 (5)	82 dB(A)	1.5 (.7)	8-1/2 (216)
59028	Self-Gen	6 (152)	3/16 (5)	85 dB(A)	1.6 (.7)	9 (229)

Model Number	Vacuum Style	Tool Dia. Inch (mm)	Dia. Orbit Inch (mm)	Sound Level	Weight Pound (kg)	Length Inch (mm)
59033	Self-Gen	3-1/2 (89)	3/32 (2.5)	82 dB(A)	1.4 (.6)	8-1/2 (216)
59038	Self-Gen	5 (127)	3/32 (2.5)	81 dB(A)	1.5 (.6)	8-1/2 (216)
59043	Self-Gen	6 (152)	3/32 (2.5)	86 dB(A)	1.5 (.7)	9 (229)
59103	Self-Gen	3 (76)	3/8 (10)	84 dB(A)	1.5 (.7)	8-1/2 (216)
59108	Self-Gen	3 (76)	3/16 (5)	83 dB(A)	1.4 (.6)	8-1/2 (216)
59113	Self-Gen	3 (76)	3/32 (2.5)	85 dB(A)	1.4 (.6)	9 (229)
59004	Central	3-1/2 (89)	3/8 (10)	79 dB(A)	1.5 (.7)	7 (178)
59009	Central	5 (127)	3/8 (10)	83 dB(A)	1.5 (.7)	7-1/4 (184)
59014	Central	6 (152)	3/8 (10)	84 dB(A)	1.6 (.7)	7-3/4 (197)
59019	Central	3-1/2 (89)	3/16 (5)	83 dB(A)	1.4 (.6)	7 (178)
59024	Central	5 (127)	3/16 (5)	81 dB(A)	1.5 (.6)	7-1/4 (184)
59029	Central	6 (152)	3/16 (5)	83 dB(A)	1.6 (.7)	7-3/4 (197)
59034	Central	3-1/2 (89)	3/32 (2.5)	81 dB(A)	1.4 (.6)	7 (178)
59039	Central	5 (127)	3/32 (2.5)	83 dB(A)	1.4 (.6)	7-1/4 (184)
59044	Central	6 (152)	3/32 (2.5)	80 dB(A)	1.5 (.7)	7-3/4 (197)
59104	Central	3 (76)	3/8 (10)	79 dB(A)	1.5 (.6)	7 (178)
59109	Central	3 (76)	3/16 (5)	83 dB(A)	1.4 (.6)	7-1/4 (184)
59114	Central	3 (76)	3/32 (2.5)	84 dB(A)	1.4 (.6)	7-3/4 (197)

**Additional Specifications:** Motor .25 hp (186 W) • Motor 12,000 RPM • Pad Thread 5/16"-24 Male • Air Inlet Thread 1/4" NPT  
 Hose I.D. Size 1/4" (6 mm) • Air Flow Rate 14 SCFM/396 L/Min • Height 3-1/2" (89 mm) • Air Pressure 90 PSIG (6.2 Bar)  
 Sound Level is the pressure measurement according to the method outlined in ISO regulation ISO-15744

# HiVac Dynorbital-Spirit®

## Air-Powered Random Orbital Sander

### Small Tool with Big Power & Vacuum Capability

- 3" diameter HiVac Dynorbital-Spirit® efficiently vacuums through 3-hole sanding pad and unique shroud design.
- Sanding pad is weight-mated to tool, ensuring low vibration and smooth finishes.
- Tool weight of 1.3 pounds (0.6 kg) minimizes operator fatigue.
- Innovative "V-Seal" protects double row balancer bearing from sanding residue for longer tool life.
- Unique "Top Hat" seal protects front motor bearing from contaminants while maintaining bearing lubrication.



**3/32"**  
(2.5 mm)  
Dia. Orbit

For Ultra-Fine Sanding



56142 Vacuum Pad  
(All HiVac Models)

All Models include  
Comfort Platform!  
(See page 5)

### Self-Generated Vacuum

- Vacuums directly through the tool's exhaust, with 1" (25 mm) vacuum port connected to optional portable dust collection system.
- Includes 56142 Vacuum Sanding Pad (3 holes, medium density Hook-Face).
- Pad accepts 3" (76 mm) diameter Hook-Face or mesh-style abrasive discs (sold separately).

### Model 59116 3/32" (2.5 mm) Orbit

Model 59115 with 3/16" (5 mm) orbit is also available.



Portable Dust Collection System  
(Optional - See Page 42)

### Central Vacuum

- 1" (25 mm) vacuum port connects to an external vacuum source, such as a portable vacuum or central vac system.
- Includes 56142 Vacuum Sanding Pad (3 holes, medium density Hook-Face).
- Pad accepts 3" (76 mm) diameter Hook-Face or mesh-style abrasive discs (sold separately).

### Model 59118 3/32" (2.5 mm) Orbit

Model 59117 with 3/16" (5 mm) orbit is also available.



Model  
59118

Model Number	Orbit Dia. Inch (mm)	Motor hp (W)	Motor RPM	Sound Level	Maximum Air Flow SCFM (L/Min)	Spindle Thread	Hose I.D. Size Inch (mm)	Air Inlet Thread	Weight Pound (kg)	Length Inch (mm)	Height Inch (mm)
59115	3/16 (5)	.25 (186)	12,000	81 dB(A)	14 (396)	5/16"-24 Female	1/4 (8)	1/4" NPT	1.3 (0.6)	7-3/4 (197)	3-3/4 (95)
59116	3/32 (2.5)	.25 (186)	12,000	81 dB(A)	14 (396)	5/16"-24 Female	1/4 (8)	1/4" NPT	1.3 (0.6)	7-3/4 (197)	3-3/4 (95)
59117	3/16 (5)	.25 (186)	12,000	79 dB(A)	14 (396)	5/16"-24 Female	1/4 (8)	1/4" NPT	1.3 (0.6)	6-1/2 (166)	3-3/4 (95)
59118	3/32 (2.5)	.25 (186)	12,000	79 dB(A)	14 (396)	5/16"-24 Female	1/4 (8)	1/4" NPT	1.3 (0.6)	6-1/2 (166)	3-3/4 (95)

**Tune-Up Kit: No. 96510** • Additional Specifications: Air Pressure 90 PSIG (6.2 Bar)



# Two-Hand Dynorbital®

## Air-Powered Random Orbital Sander

### Comfortable, Controlled Two-Hand Operation

- Long handle provides excellent comfort and control, especially when working on vertical sides of workpiece.
- Includes low profile premium urethane weight-mated sanding pad.
- 5" and 6" models are 12,000 RPM. Pads have 5/16"-24 male thread.
- 8" models are 10,000 RPM. Pads mount with 5 screws.
- Choose from two diameter orbits:

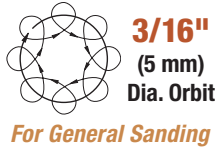

### Non-Vacuum

Pad Diameter Inch (mm)	3/16" (5 mm) Orbit Models	3/8" (10 mm) Orbit Models
5 (127)	58400	58415
6 (152)	58405	58418
8 (203)	58410	—



### Self-Generated Vacuum

- Self-generated vacuum models are ready for connection to optional portable dust collection system (50617 shown).
- Vacuum port accepts 1-1/4" diameter hose cuff for increased vacuum flow (no overskirt shroud is included).
- Not recommended for use with external or central vacuum system.

Pad Diameter Inch (mm)	3/16" (5 mm) Orbit Models	3/8" (10 mm) Orbit Models
5 (127)	58401	58416
6 (152)	58406	58419
8 (203)	58411	—



Portable Dust Collection System  
(Optional - See Page 42)

### Central Vacuum

- Ready for connection to external or central vacuum system.
- All models include combination lip seal/overskirt shroud, which offers enhanced vacuum capability and greater workpiece visibility.
- 6" diameter models include 1" outside diameter vacuum port.
- 8" diameter model includes 2" outside diameter vacuum port.

Pad Diameter Inch (mm)	3/16" (5 mm) Orbit Models	3/8" (10 mm) Orbit Models
6 (152)	58409	58420
8 (203)	58414	—



Model Number	Motor hp (W)	Motor RPM	Pad Dia. Inch (mm)	Sound Level	Maximum Air Flow SCFM (L/Min)	Hose I.D. Size Inch (mm)	Air Inlet Thread	Weight Pound (kg)	Length Inch (mm)	Height Inch (mm)
58400/58415	.45 (336)	12,000	5 (127)	82 dB(A)	23 (651)	1/4 (6)	1/4" NPT	2.5 (1.2)	11-1/16 (280)	4-15/16 (126)
58401/58416	.45 (336)	12,000	5 (127)	84 dB(A)	23 (651)	1/4 (6)	1/4" NPT	2.5 (1.1)	11-1/16 (280)	4-15/16 (126)
58405/58418	.45 (336)	12,000	6 (152)	81 dB(A)	23 (651)	1/4 (6)	1/4" NPT	2.6 (1.2)	11-3/8 (288)	4-15/16 (126)
58406/58419	.45 (336)	12,000	6 (152)	84 dB(A)	23 (651)	1/4 (6)	1/4" NPT	2.5 (1.2)	11-3/8 (288)	4-15/16 (126)
58409/58420	.45 (336)	12,000	6 (152)	84 dB(A)	23 (651)	1/4 (6)	1/4" NPT	2.7 (1.2)	11-3/8 (288)	4-15/16 (126)
58410	.45 (336)	10,000	8 (203)	82 dB(A)	23 (651)	1/4 (6)	1/4" NPT	4.0 (1.8)	12-1/2 (319)	5-5/8 (142)
58411	.45 (336)	10,000	8 (203)	85 dB(A)	23 (651)	1/4 (6)	1/4" NPT	4.0 (1.8)	12-1/2 (319)	5-5/8 (142)
58414	.45 (336)	10,000	8 (203)	85 dB(A)	23 (651)	1/4 (6)	1/4" NPT	4.2 (1.9)	12-1/2 (319)	5-5/8 (142)

Additional Specifications: Air Pressure 90 PSIG (6.2 Bar) • Thread 5/16"-24 Female • 8" models mount with 5 screws  
Tune-Up Kit: 5", 6" Models: No. 98220; 8" Models: No. 98221

# 11" Dia. Dynorbital®

## Random Orbital Sander

### Cover MORE Area in LESS Time!

- Proportionate 3/4" dia. orbit in relation to pad size assures swirl-free finish on a variety of surfaces.
- All models include 56231 Hook-Face sanding pad for abrasive discs 11-1/4" in diameter. Pad is weight-mated to tool, further reducing tool vibration levels.
- Tools include reversible Side Handle (18553), which adds to operator comfort.

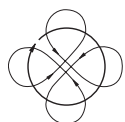

**3/4"**  
**(19 mm)**  
**Dia. Orbit**

*Achieve a Swirl-Free Finish*



## Air-Powered Models

- Powerful .7 hp air motor (2,500 RPM) offers power and efficiency.

### Model 58480 Non-Vacuum

- For use with optional non-vacuum abrasive discs. Abrasive disc covers pad holes, for non-vacuum use.

### Model 58485 Central Vacuum

- For use with optional "O" style abrasive discs, which allow dust to be drawn up through pad holes.
- Vacuum shroud has 1-1/4" outside diameter port, for connection to external or central vacuum system.



Model Number	Motor hp (W)	Motor RPM	Sound Level	Maximum Air Flow SCFM (L/Min)	Hose I.D. Size Inch (mm)	Air Inlet Thread	Air Pressure PSIG (Bar)	Weight Pound (kg)	Length Inch (mm)	Height Inch (mm)
58480	.7 (522)	2,500	83 dB(A)	27 (765)	3/8 (10)	1/4" NPT	90 (6.2)	8.3 (3.7)	17 (432)	6 (152)
58485	.7 (522)	2,500	83 dB(A)	27 (765)	3/8 (10)	1/4" NPT	90 (6.2)	9.1 (4.1)	17 (432)	6 (152)

Tune-Up Kit: No. 98224

## Electric Models

- Powerful 1.8 hp (1342 W), variable speed (0-3,000 RPM), 120 V (AC) 11 Amp electric motor offers power and efficiency. Proportionate 3/4" (19 mm) dia. orbit in relation to pad size assures swirl-free finish on a variety of surfaces. Tool has 5/8"-11 Spindle Thread.
- Double-insulated (Class II) housing, 8 ft. (2.44 m) flexible cord, and built-in tool rest.
- Includes 11" dia. x 1/2" thick Hook-Face Backing Pad (56231). Premium foam pad mounts with 5 screws.

### Model 51582 Non-Vacuum

### Model 51583 Central Vacuum

- Ready to be attached to a central vacuum system.



120 V (AC)

Model Number	Motor RPM	Max. Motor hp (W)	Voltage	Current	Phase	Frequency	Weight Pound (kg)	Length Inch (mm)	Height Inch (mm)
51582	0 - 3,000	1.8 (1,342)	120 V (AC)	11 Amp	1	60 Hz	11.8 (5.35)	21 (533)	7 (178)
51583	0 - 3,000	1.8 (1,342)	120 V (AC)	11 Amp	1	60 Hz	11.8 (5.35)	21 (533)	7 (178)



# Gear-Driven Sanders

**Air-Powered, 5", 6" and 8" Diameters**

**900 RPM for Aggressive Removal Applications**

- Unique epicycloidal sanding action allows aggressive removal of material.
- Applications include removal and leveling of large amounts of filler materials such as glue or epoxy; removing coatings. For use on materials including solid surfaces, wood and fiberglass.
- Ergonomically designed for low vibration and reduced sound levels.
- Excellent comfort and control, especially when working on vertical sides or large tabletops. Long handle allows for two-hand support of tool.

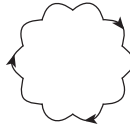

**Epicycloidal Motion**  
*Gear-Driven Tools*



## Non-Vacuum

### Model 58441 5" Diameter

- Includes 57760 Hook-Face Sanding Pad.

### Model 58442 6" Diameter

- Includes 57762 Vinyl-Face Sanding Pad.

### Model 58445 8" Diameter

- Includes 56234 Vinyl-Face Sanding Pad.



Model 58441

## Central Vacuum

- Central Vacuum models are designed for use with central vacuum system or external vacuum source.
- Includes combination lip-seal shroud/overskirt, which allows greater workpiece visibility and enhanced vacuum capability.
- Dust is extracted away from air motor (reducing contamination) for a smoother, easier path of extraction.
- Anti-clog design for efficient sanding of damp filler material.

### Model 58443 6" Diameter

- Includes 57763 Vinyl-Face Sanding Pad (6 holes).
- Vacuum shroud has 1" outside diameter vacuum port.
- Accepts optional 57765 Hook-Face Pad.

### Model 58444 6" Diameter

- Includes 57766 Hook-Face Sanding Pad (8 holes).
- Vacuum shroud has 1" outside diameter vacuum port.

### Model 58446 8" Diameter

- Includes 56235 Vinyl-Face Sanding Pad (8 holes).
- Vacuum shroud has 2" outside diameter vacuum port.



1" Outside Dia. Vacuum Port

Model 58443



2" Outside Dia. Vacuum Port (58446 Only)

Model 58446

**See page 47 for Dynabrade High-Quality Sanding Pads!**

Model Number	Motor hp (W)	Motor RPM	Pad Dia. Inch (mm)	Sound Level	Maximum Air Flow SCFM (L/Min)	Hose I.D. Size Inch (mm)	Air Inlet Thread	Weight Pound (kg)	Length Inch (mm)	Height Inch (mm)
58441	.45 (336)	900	5 (127)	80 dB(A)	23 (651)	1/4 (6)	1/4" NPT	3.6 (1.7)	11-1/16 (281)	5-5/8 (143)
58442	.45 (336)	900	6 (152)	80 dB(A)	23 (651)	1/4 (6)	1/4" NPT	3.6 (1.7)	11-1/2 (293)	5-5/8 (143)
58443	.45 (336)	900	6 (152)	81 dB(A)	23 (651)	1/4 (6)	1/4" NPT	3.8 (1.7)	11-1/2 (293)	5-5/8 (143)
58444	.45 (336)	900	6 (152)	81 dB(A)	23 (651)	1/4 (6)	1/4" NPT	3.8 (1.7)	11-1/2 (293)	5-5/8 (143)
58445	.45 (336)	900	8 (203)	82 dB(A)	23 (651)	1/4 (6)	1/4" NPT	3.9 (1.8)	12-1/2 (319)	5-9/16 (142)
58446	.45 (336)	900	8 (203)	82 dB(A)	23 (651)	1/4 (6)	1/4" NPT	4.3 (2.0)	12-1/2 (319)	5-9/16 (142)

**Tune-Up Kit: No. 98221** • Additional Specifications: Air Pressure 90 PSIG (6.2 Bar)

# Gear-Driven Sanders

## Air-Powered, 11" Diameter

### Cover MORE Area in LESS Time!

- Powerful .45 hp air motor runs at 900 RPM, for aggressive material removal.
- Extra-large 11" sanding area allows operator to cover more area in less time, leveling substrates and removing filler material with ease and efficiency.
- Useful for fabricators of large solid surface pieces, composite materials and more.
- Unique "epicycloidal" pad motion generates torque-enhanced power, for consistent material removal.
- Tool features long handle design for easy two-handed control. Operator comfort is enhanced, especially when working in vertical positions.
- Includes weight-mated sanding pad for reduced vibration levels.
- Speed control lever is conveniently located for easy thumb adjustment.
- Insulated tool housing reduces cold air transmission to the hand.
- Safety-lock throttle lever prevents accidental start-up of tool.

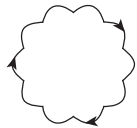

**Epicycloidal Motion**  
Gear-Driven Tools



Model 58040

## Non-Vacuum

### Model 58040 11" Diameter

- For use with non-vacuum abrasive discs.
- Includes 56231 Hook-Face sanding pad, for abrasive discs 11-1/4" (286 mm) in diameter.

## Central Vacuum

### Model 58041 11" Diameter

- For use with "O" style abrasive discs, which allow dust to be drawn up through pad holes.
- Includes 56231 Hook-Face sanding pad, for abrasive discs 11-1/4" in diameter.
- Vacuum shroud has 1-1/4" diameter port, for connection to external vacuum system.



Model 58041

**See page 48  
for Dynabrade  
High-Quality  
Sanding Pads!**

Model Number	Motor hp (W)	Motor RPM	Pad Dia. Inch (mm)	Sound Level	Maximum Air Flow SCFM (L/Min)	Hose I.D. Size Inch (mm)	Air Inlet Thread	Weight Pound (kg)	Length Inch (mm)	Height Inch (mm)
58040	.45 (336)	900	11 (279)	83 dB(A)	23 (651)	1/4 (6)	1/4" NPT	5.0 (2.3)	14-3/32 (358)	5-10/16 (143)
58041	.45 (336)	900	11 (279)	83 dB(A)	23 (651)	1/4 (6)	1/4" NPT	5.5 (2.5)	14-3/32 (358)	5-10/16 (143)

**Tune-Up Kit: No. 98576** • Additional Specifications: Air Pressure 90 PSIG (6.2 Bar)



# DynaLocke®

## Air-Powered Dual-Action Sander

### Combination Rotary and Random Orbital Sander

- 12,000 RPM DynaLocke® is truly “two tools in one,” easily changing from a rotary Disc Sander to Random Orbital Sander with the turn of a dial.
- Great on composite materials. Utilized for leveling glue seams on Corian® and other solid surfaces.
- Switch is recessed within tool grip to prevent accidental engaging.



**Rotary Motion**

For Stripping and Blending

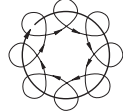

**3/16" Dia. Orbit**

For Swirl-Free Finishes



## Non-Vacuum

### Model 58460 3" Diameter

- Includes 56087 Hook-Face Pad.

### Model 58465 3-1/2" Diameter

- Includes 54313 Hook-Face Pad.

### Model 58430 5" Diameter

- Includes 54325 Hook-Face Pad.

### Model 58435 6" Diameter

- Includes 54327 Hook-Face Pad.

See page 44 for Dynabrade High-Quality Sanding Pads!



Model 58430

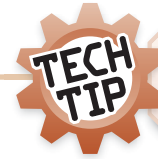

Tool should be completely stopped before changing sanding action.

## Self-Generated Vacuum

- Self-Generated Vacuum models are ready for connection to optional portable dust collection system.
- Tool has 1-1/4" outside diameter vacuum port, allowing increased air flow.
- Designed to vacuum in random orbital mode only.

### Model 58461 3" Diameter

- Includes 56087 Hook-Face Pad.

### Model 58466 3-1/2" Diameter

- Includes 54313 Hook-Face Pad.

### Model 58431 5" Diameter

- Includes 54326 Hook-Face Pad.

### Model 58436 6" Diameter

- Includes 54328 Hook-Face Pad.



Model 58436

50617 Portable Dust Collection System (Optional - See Page 42)

Corian is a trademark of DuPont

Model Number	Motor hp (W)	Motor RPM	Pad Dia. Inch (mm)	Sound Level	Maximum Air Flow SCFM (L/Min)	Hose I.D. Size Inch (mm)	Air Inlet Thread	Tool Thread	Weight Pound (kg)	Length Inch (mm)	Height Inch (mm)
58460	.45 (336)	12,000	3 (76)	81 dB(A)	23 (651)	1/4 (6)	1/4" NPT	5/16"-24 Female	2.35 (1.0)	10-5/16 (263)	5-3/8 (137)
58461	.45 (336)	12,000	3 (76)	86 dB(A)	23 (651)	1/4 (6)	1/4" NPT	5/16"-24 Female	2.35 (1.0)	10-5/16 (263)	5-3/8 (137)
58465	.45 (336)	12,000	3-1/2 (89)	80 dB(A)	23 (651)	1/4 (6)	1/4" NPT	5/16"-24 Female	2.35 (1.0)	10-5/16 (263)	5-3/8 (137)
58466	.45 (336)	12,000	3-1/2 (89)	85 dB(A)	23 (651)	1/4 (6)	1/4" NPT	5/16"-24 Female	2.35 (1.0)	10-5/16 (263)	5-3/8 (137)
58430	.45 (336)	12,000	5 (127)	82 dB(A)	23 (651)	1/4 (6)	1/4" NPT	5/16"-24 Female	2.7 (1.2)	11-1/16 (280)	5-1/8 (131)
58431	.45 (336)	12,000	5 (127)	82 dB(A)	23 (651)	1/4 (6)	1/4" NPT	5/16"-24 Female	2.6 (1.2)	11-1/16 (280)	5-1/8 (131)
58435	.45 (336)	12,000	6 (152)	82 dB(A)	23 (651)	1/4 (6)	1/4" NPT	5/16"-24 Female	2.8 (1.2)	11-1/2 (293)	5-1/8 (131)
58436	.45 (336)	12,000	6 (152)	85 dB(A)	23 (651)	1/4 (6)	1/4" NPT	5/16"-24 Female	2.7 (1.2)	11-1/2 (293)	5-1/8 (131)

Tune-Up Kit: No. 98220

# Dynabug® Sander

## Air-Powered "Jitter-Bug" Type Orbital

### Featheredge, Finish, Sand and Blend

- Precise 3/32" orbital motion is ideal for achieving a controlled, ultra-fine finish on a variety of surfaces.
- 3/16" orbital motion is available for general sanding applications.
- Powerful air motor utilizes 16 SCFM at 90 PSIG.
- Tools have heavy-duty clips to accept traditional 3-2/3" x 9" abrasive sheets (rolls also available).



**Orbital Motion**  
(All models on page)



Model 57810

### Non-Vacuum

- Includes premium 57850 Vinyl-Face Sanding Pad, 3-2/3" x 7".

**Model 57810** 3/32" Dia. Orbit

**Model 57800** 3/16" Dia. Orbit

**All Models include Comfort Platform!**  
(See page 5)

### Self-Generated Vacuum

- Ready for connection to optional portable self-contained dust collection systems.
- Includes premium 57855 Vinyl-Face Sanding Pad for PSA (abrasive-backed) abrasives.

**Model 57811** 3/32" Dia. Orbit

**Model 57801** 3/16" Dia. Orbit



Model 57811

Portable Dust Collection System  
(Optional - See Page 42)

### Central Vacuum

- Has 1" outside diameter vacuum port for easy central vacuum hose hook-up.
- Includes premium 57855 Vinyl-Face Sanding Pad for PSA (abrasive-backed) abrasives.

**Model 57814** 3/32" Dia. Orbit

**Model 57804** 3/16" Dia. Orbit

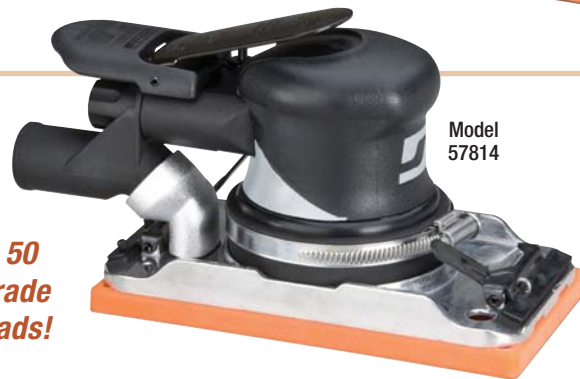

Model 57814

**See page 50 for Dynabrade Sanding Pads!**



**WATCH Tool at Work!**

Model Number	Motor hp (W)	Motor RPM	Sound Level	Maximum Air Flow SCFM (L/Min)	Hose I.D. Size Inch (mm)	Air Inlet Thread	Weight Pound (kg)	Length Inch (mm)	Height Inch (mm)
57800	.24 (179)	8,000	79 dB(A)	16 (453)	1/4 (6)	1/4" NPT	2.8 (1.3)	7-1/4 (184)	4-1/4 (108)
57801	.24 (179)	8,000	76 dB(A)	16 (453)	1/4 (6)	1/4" NPT	2.8 (1.3)	7-1/4 (184)	4-1/4 (108)
57804	.24 (179)	8,000	80 dB(A)	16 (453)	1/4 (6)	1/4" NPT	2.8 (1.3)	7-1/4 (184)	4-1/4 (108)
57810	.28 (209)	10,000	77 dB(A)	18 (510)	1/4 (6)	1/4" NPT	2.8 (1.3)	7-1/4 (184)	4-1/4 (108)
57811	.28 (209)	10,000	74 dB(A)	18 (510)	1/4 (6)	1/4" NPT	2.6 (1.2)	7-1/4 (184)	4-1/4 (108)
57814	.28 (209)	10,000	81 dB(A)	18 (510)	1/4 (6)	1/4" NPT	2.6 (1.2)	7-1/4 (184)	4-1/4 (108)

**Tune-Up Kit: No. 96024** • Additional Specifications: Air Pressure 90 PSIG (6.2 Bar)



# Dynabug® II

## Air-Powered Orbital Finishing Sander

### Featheredge, Finish, Sand and Blend

- Powerful .15 hp (112 W), 10,000 RPM air motor. Utilizes just 13 SCFM (368 L/Min) at 90 PSIG (6.2 Bar).
- Precise 3/32" orbital motion is ideal for achieving a controlled, ultra-fine finish on a variety of surfaces.
- Compact size is ideal for all operators, including those with smaller hands.
- Engineered and tested to ensure less tool vibration than any competitive model!
- Lighter tool weight minimizes hand and arm fatigue. Perfect for vertical applications.
- Rectangular shape sands deep into corners, where round pads cannot reach.



**Orbital Motion**  
(All models on page)



## Non-Vacuum

### Model 58500

- Includes 56315 Hook-Face Sanding Pad, 74 mm wide x 109 mm long (approximately 3" x 4-1/4"), for accepting optional Hook-Face abrasive sheets.

### Model 58503

- Includes 56317 Hook-Face Sanding Pad, 80 mm wide x 130 mm long (approximately 3-1/4" x 5"), for accepting optional Hook-Face abrasive sheets.

### Model 58509

- Includes 56355 Vinyl-Face Sanding Pad, 74 mm wide x 109 mm long (approximately 3" x 4-1/4").



Model  
58500

**All Models include  
Comfort Platform!**  
(See page 5)

**See page 50  
for Dynabrade  
Sanding Pads!**

### Model 58507 with Heavy-Duty Clips

- Tool has specially designed pad base assembly with heavy-duty clips. Clips are designed for heavy-duty use, accepting up to four sheets at once. Ideal for high-production workplaces.
- Includes 56354 vinyl-face Sanding Pad, 68 mm wide by 175 mm long (approximately 2-3/4" x 7"). Weight-mated pad screws directly to pad base assembly.
- Accepts optional abrasive sheets cut from 70 mm (2-3/4") wide abrasive rolls. Four sheets of this width may also be cut from sheets 229 mm wide x 280 mm long (9" x 11").



Model  
58507

Model Number	Motor hp (W)	Motor RPM	Sound Level	Maximum Air Flow SCFM (L/Min)	Hose I.D. Size Inch (mm)	Air Inlet Thread	Weight Pound (kg)	Length Inch (mm)	Height Inch (mm)
58500	.15 (112)	10,000	78 dB(A)	13 (368)	1/4 (6)	1/4" NPT	1.6 (.7)	5-3/4 (147)	3-1/2 (91)
58503	.15 (112)	10,000	78 dB(A)	13 (368)	1/4 (6)	1/4" NPT	1.6 (.7)	6-1/4 (165)	3-1/2 (91)
58507	.15 (112)	10,000	79 dB(A)	13 (368)	1/4 (6)	1/4" NPT	2.1 (.95)	7-1/16 (180)	3-3/4 (94)
58509	.15 (112)	10,000	78 dB(A)	13 (368)	1/4 (6)	1/4" NPT	1.6 (.7)	5-3/4 (147)	3-1/2 (91)

Tune-Up Kit: No. 98222

# Dynabug® II

## Air-Powered Orbital Finishing Sander

### Featheredge, Finish, Sand and Blend

- Precise 3/32" orbital motion is ideal for achieving a controlled, ultra-fine finish on a variety of surfaces.
- Compact size is ideal for all operators, including those with smaller hands.
- Lighter tool weight minimizes hand and arm fatigue. Perfect for vertical applications.



#### Orbital Motion

(All models on page)

### Self-Generated Vacuum

- Self-Generated Vacuum models vacuum through the tool's exhaust. Tool has 1" outside diameter vacuum port, ready for connection to optional dust collection systems. Includes Hook-Face sanding pad, for optional Hook-Face vacuum abrasive sheets.

#### Model 58501

- Includes 56316 Vacuum Sanding Pad, 74 mm wide x 109 mm long (approximately 3" x 4-1/4").

#### Model 58504

- Includes 56319 Vacuum Sanding Pad, 80 mm wide x 130 mm long (approximately 3-1/4" x 5"), with eight vacuum holes.

### Central Vacuum

- Central Vacuum models have 1" outside diameter vacuum port, ready for connection to external vacuum source. Includes Hook-Face sanding pad, for optional Hook-Face vacuum abrasive sheets.

#### Model 58502

- Includes 56316 Vacuum Sanding Pad, 74 mm wide by 109 mm long (approximately 3" x 4-1/4").

#### Model 58505

- Includes 56319 Vacuum Sanding Pad, 80 mm wide by 130 mm long (approximately 3-1/4" x 5"), with eight vacuum holes.

#### Model 58506 "Delta Style"

- Includes 56323 "Delta Style" Vacuum Sanding Pad, 99 mm wide (at wider end) by 143 mm long (approximately 4" x 5-3/4"), with seven vacuum holes. Unique pad has curved edges for sanding rounded areas, and pointed tip for reaching into tight corners.

All Models include  
Comfort Platform!  
(See page 5)



Portable Dust Collection System  
(Optional - See Page 42)



Model  
58502

See page 50  
for Dynabrade  
Sanding Pads!



Model 58506  
"Delta Style"



56323  
"Delta Style"  
Pad

Model Number	Motor hp (W)	Motor RPM	Sound Level	Maximum Air Flow SCFM (L/Min)	Hose I.D. Size Inch (mm)	Air Inlet Thread	Weight Pound (kg)	Length Inch (mm)	Height Inch (mm)
58501	.15 (112)	10,000	75 dB(A)	13 (368)	1/4 (6)	1/4" NPT	1.7 (.75)	8-1/4 (212)	3-1/2 (91)
58502	.15 (112)	10,000	81 dB(A)	13 (368)	1/4 (6)	1/4" NPT	1.6 (.7)	7 (180)	3-1/2 (91)
58504	.15 (112)	10,000	75 dB(A)	13 (368)	1/4 (6)	1/4" NPT	1.7 (.75)	8-3/4 (222)	3-3/4 (94)
58505	.15 (112)	10,000	81 dB(A)	13 (368)	1/4 (6)	1/4" NPT	1.6 (.7)	7-1/2 (190)	3-1/2 (91)
58506	.15 (112)	10,000	81 dB(A)	13 (368)	1/4 (6)	1/4" NPT	1.6 (.7)	8-3/4 (222)	3-1/2 (91)

Tune-Up Kit: No. 98222



# Dynabug® "Model T"

## Air-Powered Orbital Finishing Sander

### Featheredge, Finish, Sand and Blend

- 3/32" diameter orbital action is ideal for fine finishes.
- Lightweight...only 1 lb.! Palm-style, ergonomic design features low profile grip for greater operator comfort and control.
- Operates 9 SCFM at 90 PSIG. Can be run by as little as 3 horsepower compressor.
- Low maintenance – easy to repair. Turbine-style vaneless air motor needs no oil!
- Easy interchangeable sanding pads. Uses reattachable and PSA (adhesive-backed) abrasive sheets and discs; coated and non-woven nylon.
- Each model includes 96455 Urethane Inlet Hose.

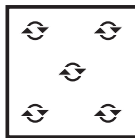

Orbital Motion

### Non-Vacuum

#### Model 57920 4" x 4-5/16" Pad (with clips)

- Includes 57999 Vinyl-Face Pad.

#### Model 57923 4-1/4" x 4-1/2" "Quarter-Sheet" Pad

- Includes 57998 Hook-Face Pad.

#### Model 57925 4-1/4" x 4-1/2" "Quarter-Sheet" Pad

- Includes 56244 Vinyl-Face Pad.

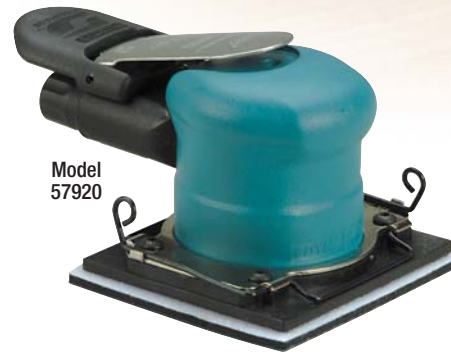

Model 57920

**All Models on page include Comfort Platform!**  
(See page 5)



Equipped with 96455 Urethane Inlet Hose

(All models on page)

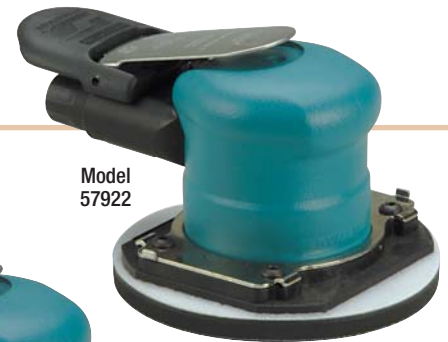

Model 57922

#### Model 57922 5" Diameter Pad

- Includes 56249 Vinyl-Face Pad.

#### Model 57924 5" Diameter Pad

- Includes 56248 Hook-Face Pad.

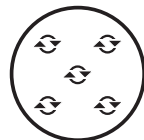

Orbital Motion

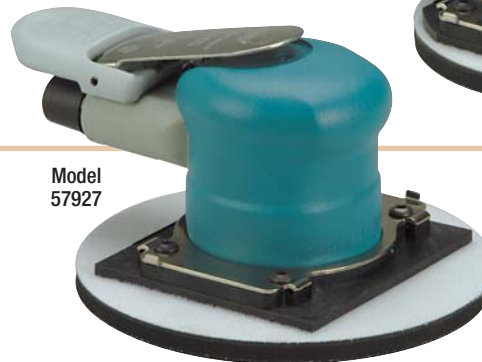

Model 57927

**See page 50 for Dynabrade Sanding Pads!**

#### Model 57926 6" Diameter Pad

- Includes 56269 Vinyl-Face Pad.

#### Model 57927 6" Diameter Pad

- Includes 56268 Hook-Face Pad.

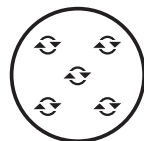

Orbital Motion

Model Number	Motor RPM	Sound Level	Maximum Air Flow SCFM (L/Min)	Hose I.D. Size Inch (mm)	Air Inlet Thread	Weight Pound (kg)	Length Inch (mm)	Height Inch (mm)
57920	20,000	68 dB(A)	9 (255)	1/4 (6)	1/4" NPT	1 (.45)	5 (127)	3 (76)
57923	20,000	68 dB(A)	9 (255)	1/4 (6)	1/4" NPT	1 (.5)	5-1/2 (140)	3 (76)
57925	20,000	68 dB(A)	9 (255)	1/4 (6)	1/4" NPT	1 (.5)	5 (127)	3 (76)
57922	20,000	68 dB(A)	9 (255)	1/4 (6)	1/4" NPT	1 (.5)	5-1/2 (140)	3 (76)
57924	20,000	68 dB(A)	9 (255)	1/4 (6)	1/4" NPT	1 (.5)	5-1/2 (140)	3 (76)
57926	20,000	68 dB(A)	9 (255)	1/4 (6)	1/4" NPT	1 (.5)	5 (127)	3 (76)
57927	20,000	68 dB(A)	9 (255)	1/4 (6)	1/4" NPT	1 (.5)	5 (127)	3 (76)

Tune-Up Kit: No. 96169 • Additional Specifications: Air Pressure 90 PSIG (6.2 Bar)

# Dynabug® “Model T”

## Air-Powered Orbital Finishing Sander

### Featheredge, Finish, Sand and Blend

- 3/32" diameter orbital action is ideal for fine finishes.
- Lightweight...only 1 lb.! Palm-style, ergonomic design features low profile grip for greater operator comfort and control.
- Operates 17 SCFM at 90 PSIG. Can be run by as little as 3 horsepower compressor.
- Low maintenance – easy to repair. Turbine-style vaneless air motor needs no oil!
- Easy interchangeable sanding pads. Uses reattachable and PSA (adhesive-backed) abrasive sheets and discs; coated and non-woven nylon.
- Each model includes 96455 Urethane Inlet Hose.

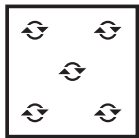

**Orbital Motion**  
(All models on page)

**All Models on page include Comfort Platform!**  
(See page 5)

## Self-Generated Vacuum

### Model 58070 4-1/4" x 4-1/2" “Quarter-Sheet” Pad

- Ready for connection to optional portable self-contained dust collection systems.
- Has 1" outside diameter vacuum port for easy vacuum hose connection.
- Includes 56286 Vinyl-Face Vacuum Pad.



Model 58070

50617 Portable Dust Collection System (Optional - See Page 42)

### Model 58075 4-1/4" x 4-1/2" “Quarter-Sheet” Pad

- Ready for connection to optional portable self-contained dust collection systems.
- Has 1" outside diameter vacuum port for easy vacuum hose hook-up.
- Includes 56285 Hook-Face Vacuum Pad.

## Central Vacuum

### Model 57928 4-1/4" x 4-1/2" “Quarter-Sheet” Pad

- Has 1" outside diameter vacuum port for easy central vacuum connection.
- Includes 56286 Vinyl-Face Vacuum Pad.



Model 57928

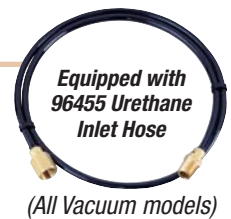

Equipped with 96455 Urethane Inlet Hose

(All Vacuum models)

### Model 57929 4-1/4" x 4-1/2" “Quarter-Sheet” Pad

- Has 1" outside diameter vacuum port for easy central vacuum connection.
- Includes 56285 Hook-Face Vacuum Pad.

**See page 50 for Dynabrade Sanding Pads!**

Model Number	Motor RPM	Sound Level	Maximum Air Flow SCFM (L/Min)	Hose I.D. Size Inch (mm)	Air Inlet Thread	Weight Pound (kg)	Length Inch (mm)	Height Inch (mm)
58070	16,000	82 dB(A)	17 (481)	1/4 (6)	1/4" NPT	1.5 (0.7)	8 (203)	4 (102)
58075	16,000	82 dB(A)	17 (481)	1/4 (6)	1/4" NPT	1.5 (0.7)	8 (203)	4 (102)
57928	20,000	73 dB(A)	9 (255)	1/4 (6)	1/4" NPT	1 (.5)	5 (127)	3 (76)
57929	20,000	73 dB(A)	9 (255)	1/4 (6)	1/4" NPT	1 (.5)	5 (127)	3 (76)

**Tune-Up Kit: No. 96169** • Additional Specifications: Air Pressure 90 PSIG (6.2 Bar)



# Dynafine® Detail Sander

## Air-Powered Finishing Sander

### Excellent for Use in Tight Corners

- Excellent for cleaning wood edges and corners.
- Ideal for use on furniture, shutters, moldings, door jambs, metal parts and much more.
- Features 1/32" dia. orbital action for superior finishes.
- Handle is offset 7° for greater operator comfort and control.
- Uses Hook-Face and PSA (adhesive-backed) coated, non-woven nylon and sponge abrasives.



**Orbital Motion**  
(All models on page)

## Non-Vacuum

### Model 57900

- Detail Sander includes triangular and tear-drop Hook-Face pads; also includes 94407 Flow-Control Dynaswivel®.

### 57910 Versatility Kit

- Includes 57900 tool with Hook-Face and PSA (adhesive-backed) pads, 94407 Flow-Control Dynaswivel® (not shown) and an assortment of coated and non-woven nylon abrasives.



Model 57900

## Self-Generated Vacuum

### Model 58015

- Utilizes tool's exhaust to create strong vacuum suction.
- 1" (25 mm) diameter vacuum port ready for connection to optional portable self-contained dust collection system (such as 50617 Flex-Hose System, sold separately).

**See page 49 for  
Dynabrade Sanding Pads!**



Model 58015

Portable Dust Collection System  
(Optional - See Page 42)

## Central Vacuum

### Model 58017

- 1-1/4" (32 mm) diameter vacuum port ready for connection to external or central vacuum system.
- Includes Conductive Hose and Cuffs to shield operator from electrostatic discharge (ESD).



Model 58017



**WATCH the  
Dynafine®  
at Work!**

Model Number	Motor hp (W)	Motor RPM	Sound Level	Maximum Air Flow SCFM (L/Min)	Hose I.D. Size Inch (mm)	Air Inlet Thread	Air Pressure PSIG (Bar)	Weight Pound (kg)	Length Inch (mm)	Height Inch (mm)
57900	.12 (89)	13,000	65 dB(A)	20 (566)	1/4 (6)	1/4" NPT	90 (6.2)	1.6 (.7)	9 (229)	3-3/4 (95)
58015	.12 (89)	15,000	88 dB(A)	20 (566)	1/4 (6)	1/4" NPT	90 (6.2)	1.8 (.8)	9 (229)	4 (102)
58017	.12 (89)	15,000	85 dB(A)	20 (566)	1/4 (6)	1/4" NPT	90 (6.2)	1.8 (.8)	9 (229)	4 (102)

Tune-Up Kit: No. 96236

# Dynafine® Finger Sander

## Air-Powered Finishing Sander

### Model 57930

- Ideal for use on wood, varnished surfaces, stone, glass, marble, plastic, composites, painted surfaces, metal and more!
- Tool includes 57932 Offset Sanding Arm (with 1/8" thick sponge platen), 94407 Flow-Control Dynaswivel® (not shown) and an assortment of abrasives.
- Handle is offset 7° for greater operator comfort and control.
- 1/32" dia. orbital action for fine finishes.



Model Number	Motor hp (W)	Motor RPM	Sound Level	Maximum Air Flow SCFM (L/Min)	Hose I.D. Size Inch (mm)	Air Inlet Thread	Weight Pound (kg)	Length Inch (mm)	Height Inch (mm)
57930	.12 (89)	15,000	65 dB(A)	20 (566)	1/4 (6)	1/4" NPT	1.6 (.7)	11-3/4 (298)	4 (102)

**Tune-Up Kit: No. 96236** • Additional Specifications: Air Pressure 90 PSIG (6.2 Bar)

# Dynafine® Raised Panel Sander

## For Raised Panels & Linear Profiles

### Model 57906

- 57906 Dynafine® includes 57956 Raised Panel Pad (4" long x 3/4" wide), with unique angled edges for sanding in tight corners and on raised panel edges.
- 57956 Raised Panel Pad is a premium urethane, medium density Hook-Face pad (1/2" thick), which accepts both coated abrasive and non-woven nylon sheets.
- Excellent for sanding raised panels and linear profiles. Also ideal for use on furniture, shutters, moldings and more.



Model Number	Motor hp (W)	Motor RPM	Sound Level	Maximum Air Flow SCFM (L/Min)	Hose I.D. Size Inch (mm)	Air Inlet Thread	Weight Pound (kg)	Length Inch (mm)	Height Inch (mm)
57906	.12 (89)	13,000	65 dB(A)	20 (566)	1/4 (6)	1/4" NPT	1.6 (.7)	9 (229)	3-3/4 (95)

**Tune-Up Kit: No. 96236** • Additional Specifications: Air Pressure 90 PSIG (6.2 Bar)

# Dynafine® Dynascraper

## For Sealant & Adhesive Removal

### Model 47915

- Dynafine® model includes 91220 Scraper Blade, 30 mm width, 55 Rockwell hardness. Blade may be resharpened for longer life!
- Ideal for quick removal of sealant, adhesives and more, in MRO, construction, and general purpose accounts.
- Tool also includes 94407 Flow-Control Dynaswivel®.
- Accepts all optional accessories compatible with other Dynafine® models.
- 91121 Scraper Blade Accessory Kit may be ordered separately, for added versatility.



Model Number	Motor hp (W)	Motor RPM	Sound Level	Maximum Air Flow SCFM (L/Min)	Blade Width	Air Inlet Thread	Weight Pound (kg)	Length Inch (mm)	Height Inch (mm)
47915	.4 (522)	15,000	77 dB(A)	15 (416)	30 mm	1/4" NPT	1.6 (.74)	9.1 (232)	3.7 (94)

**Tune-Up Kit: No. 96541** • Additional Specifications: Air Pressure 90 PSIG (6.2 Bar) • Hose I.D. Size 1/4" (6 mm)



# “Backsplash” Sander

## Air-Powered Dynafine® Finishing Sander

### A Must for Solid Surface Fabricators

- Excellent for fabricating solid surface covered backsplashes; ideal for cleaning metal edges and corners.
- Air motor features 1/32" diameter orbital action for achieving a superior finish.
- Lightweight tool of only 1.6 lbs!
- Low profile housing allows easy access in hard-to-reach areas. Handle is offset 7° for greater operator comfort and control.

### Model 58000

- Includes 58021 and 58024 Backsplash Pads. Also includes 94407 Dynaswivel® with fingertip air-flow control dial.

### 58010 Versatility Kit

- Includes tool with all five sanding pads shown below and an assortment of PSA (adhesive-backed) abrasives.

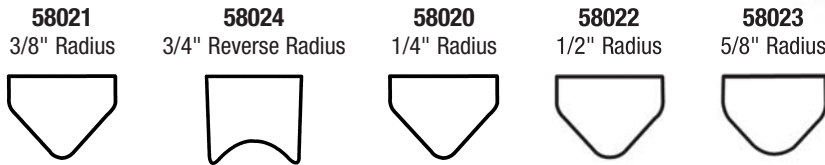

Model 58000

Model Number	Motor hp (W)	Motor RPM	Sound Level	Maximum Air Flow SCFM (L/Min)	Hose I.D. Size Inch (mm)	Air Inlet Thread	Weight Pound (kg)	Length Inch (mm)	Height Inch (mm)
58000	.12 (89)	13,000	65 dB(A)	20 (566)	1/4 (6)	1/4" NPT	1.6 (.7)	9 (229)	3-3/4 (95)

Tune-Up Kit: No. 96236 • Additional Specifications: Air Pressure 90 PSIG (6.2 Bar)

# File Board Sander

## 11" Long In-Line File Board Sander

### Great on Wood, Composites & More!

- Tool features high quality gear for smooth-running in-line sanding action.
- 2,400 strokes per minute. 3/8" long sanding stroke.
- For use with PSA (adhesive-backed) coated and non-woven sheets and rolls.
- Sanding pad can be rotated 360°, for adjusting to most efficient position.



## Non-Vacuum

### Model 51350

- Includes 2-3/4" wide x 11" long 57512 Premium Urethane PSA (adhesive-backed) Sanding Pad with clips.
- Also accepts 2-3/4" wide x 11" long pads without clips, and 2-3/4" wide x 8" long non-vacuum pads.



Model 51350

Model Number	Motor hp (W)	Strokes Per Minute	Sound Level	Maximum Air Flow SCFM (L/Min)	Hose I.D. Size Inch (mm)	Air Inlet Thread	Weight Pound (kg)	Length Inch (mm)	Height Inch (mm)
51350	.3 (186)	2,400	81 dB(A)	18 (510)	1/4 (6)	1/4" NPT	3.1 (1.4)	11 (279)	3-3/4 (95)

Tune-Up Kit: No. 96531 • Additional Specifications: Air Pressure 90 PSIG (6.2 Bar)

# Dynaline Sander

## Air-Powered In-Line Finishing Sander

### Great on Wood, Composites & Solid Surfaces

- 2,400 strokes per minute at 90 PSIG (6.2 Bar).
- Uses adhesive-backed coated and non-woven nylon sheets and rolls.
- Quality constructed pad is weight-mated to tool for low vibration, smooth operation and superior finishes.

## Non-Vacuum

### Model 57400

- Includes 2-3/4" wide x 8" long vinyl-face non-vacuum Sanding Pad (57454).

### 57405 Versatility Kit

- Includes 57400 Dynaline; 57852 Sanding Pad (3-2/3" wide x 7" long premium urethane, long nap, Hook-Face pad); plus medium grade (94951) and very fine (94956) abrasive impregnated non-woven nylon sheets.

### Model 57407 with Clips

- Includes 2-3/4" wide x 8" long vinyl-face non-vacuum Sanding Pad with clips (57460).
- Accepts abrasives 2-3/4" wide x 11" long.
- Up to four abrasive sheets may be attached, ideal for high-production workplaces.



All Models include  
Comfort Platform!  
(See page 5)



## Self-Generated Vacuum

### Model 57401

- Includes 2-3/4" wide x 8" long vinyl-face, vacuum sanding pad (57455).
- Ready for connection to optional portable self-contained dust collection systems.

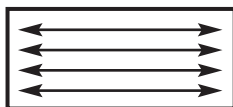

**In-Line Motion**  
(All models on page)

## Central Vacuum

### Model 57404

- Includes 2-3/4" wide x 8" long vinyl-face, vacuum sanding pad (57455).
- Has 1" outside diameter vacuum port for easy central vacuum hose connection.

See page 48  
for Dynabrade  
Sanding Pads!



Model Number	Motor hp (W)	Motor RPM	Sound Level	Maximum Air Flow SCFM (L/Min)	Hose I.D. Size Inch (mm)	Air Inlet Thread	Weight Pound (kg)	Length Inch (mm)	Height Inch (mm)
57400	.3 (186)	2,400	79 dB(A)	18 (510)	1/4 (6)	1/4" NPT	2.6 (1.2)	7 (178)	3-3/4 (95)
57401	.3 (186)	2,400	79 dB(A)	18 (510)	1/4 (6)	1/4" NPT	2.6 (1.2)	7 (178)	3-3/4 (95)
57404	.3 (186)	2,400	80 dB(A)	18 (510)	1/4 (6)	1/4" NPT	2.6 (1.2)	7 (178)	3-3/4 (95)
57407	.3 (186)	2,400	79 dB(A)	18 (510)	1/4 (6)	1/4" NPT	2.6 (1.2)	7 (178)	3-3/4 (95)

Tune-Up Kit: No. 96107 • Additional Specifications: Air Pressure 90 PSIG (6.2 Bar)



# Dynabrade Trim Routers

**.4 hp, .7 hp & 1 hp Models Available – Complete Models & Replacement Motors**

*Trim Routers offer Dynabrade power and performance, with ergonomic features to maximize comfort and efficiency! Available as complete models and replacement motors, these tools are essential to industries such as aerospace, composites, plastics, marine, fiberglass, woodworking and more!*

## .4 hp (298 W) Trim Routers

- Ideal for countless trim routing applications, using templates and template guides on surfaces such as carbon fiber, composites, laminates and more!
- .4 hp air motor is **governor-controlled** to maintain consistent speed under load.
- “Soft touch” composite tool housing is ergonomically designed for operator comfort.
- Each model includes 1/4" collet, for accepting optional 1/4" router bits.
- Safety-lock throttle lever prevents accidental tool startup, for enhanced workplace safety.

### Complete Trim Router

**Model 51854 30,000 RPM, Rear Exhaust**

**Model 51862 30,000 RPM, Front Exhaust**

- Each tool includes router nose assembly and 51861 template guide (with 1-1/2" dia. base). Nose assembly and template guide are nickel-plated for added durability.
- Allows quick adjustment of trim housing depth. Two wrenches included.

### Trim Router Replacement Motor

**Model 51814 30,000 RPM, Rear Exhaust**

**Model 51815 30,000 RPM, Front Exhaust**

- Easy motor replacement for most popular .4 hp Trim Router tools!
- Motor includes adapter (1-1/8"-18 male thread) for use with existing inventories of router nose assemblies.

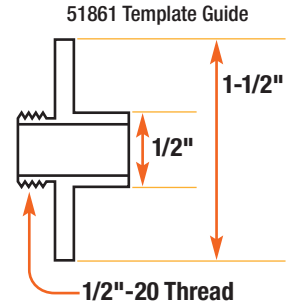

Model Number	Motor hp (W)	Motor RPM	Sound Level	Maximum Air Flow SCFM (L/Min)	Collet	Air Inlet Thread	Hose I.D. Inch (mm)	Weight Pound (kg)	Length Inch (mm)	Height Inch (mm)
51854	.4 (298)	30,000	77 dB(A)	23 (651)	1/4"	1/4" NPT	1/4 (6)	1.3 (.6)	7.4 (188)	1.7 (44)
51862	.4 (298)	30,000	81 dB(A)	21 (595)	1/4"	1/4" NPT	1/4 (6)	1.3 (.6)	7.5 (191)	1.5 (38)
51814	.4 (298)	30,000	77 dB(A)	23 (651)	1/4"	1/4" NPT	1/4 (6)	.75 (.34)	6.4 (163)	1.7 (44)
51815	.4 (298)	30,000	81 dB(A)	21 (595)	1/4"	1/4" NPT	1/4 (6)	.8 (38)	6.3 (160)	1.5 (38)

**Tune-Up Kit: No. 96541** • Additional Specifications: Air Pressure 90 PSIG (6.2 Bar)

**HIGHEST QUALITY!**

**Discover The Dynabrade Difference!**

**FREE ON-SITE DEMOS!**

**FASTEST SHIPPING!**



**BEST SERVICE!**

# Dynabrade Trim Routers

## Air-Powered Tool for Routing Applications

### .7 hp (522 W) Trim Routers

- Ideal for countless trim routing applications, using templates and template guides on surfaces such as carbon fiber, composites, laminates and more!
- Each model includes 1/4" collet, for accepting optional 1/4" router bits.
- Safety-lock throttle lever prevents accidental tool startup, for enhanced workplace safety.

### Complete Trim Router

#### Model 51857 20,000 RPM, Rear Exhaust

#### Model 51863 20,000 RPM, Front Exhaust

- Tool includes router nose assembly and 51861 template guide (with 1-1/2" dia. base). Nose assembly and template guide are nickel-plated for added durability.
- Allows quick adjustment of trim housing depth. Two wrenches included.

### Trim Router Replacement Motor

#### Model 51817 20,000 RPM, Rear Exhaust

#### Model 51816 20,000 RPM, Front Exhaust

- Easy motor replacement for most popular .7 hp Trim Router tools!
- Motor includes adapter (1-3/8"-18 male thread) for use with existing inventories of router nose assemblies.

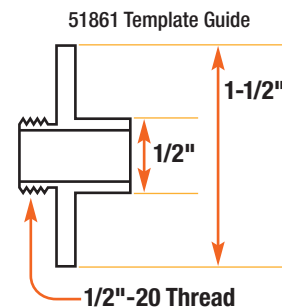

Model Number	Motor hp (W)	Motor RPM	Sound Level	Maximum Air Flow SCFM (L/Min)	Collet	Air Inlet Thread	Hose I.D. Inch (mm)	Weight Pound (kg)	Length Inch (mm)	Height Inch (mm)
51857	.7 (522)	20,000	78 dB(A)	38 (1,076)	1/4"	1/4" NPT	3/8 (10)	2.2 (1)	8.4 (212)	2 (51)
51863	.7 (522)	20,000	85 dB(A)	37 (1,048)	1/4"	1/4" NPT	3/8 (10)	2.3 (1)	8 (203)	1.8 (46)
51817	.7 (522)	20,000	78 dB(A)	38 (1,076)	1/4"	1/4" NPT	3/8 (10)	1.7 (.77)	7.2 (182)	2 (51)
51816	.7 (522)	20,000	85 dB(A)	37 (1,048)	1/4"	1/4" NPT	3/8 (10)	1.75 (78)	6.8 (173)	1.8 (46)

**Tune-Up Kit: No. 96529** • Additional Specifications: Air Pressure 90 PSIG (6.2 Bar)

### Model 51330 – Complete Trim Router 20,000 RPM, Front Exhaust

- Ideal for chamfers and roundover cuts on hardwoods, softwoods, solid surfaces or plastics. Great for laminate trimming, surface planing, beveling and cornering.
- Tool accepts optional high-speed steel router bits with 1/4" diameter shank capacity. Also accepts optional 1/8" collet insert, for mounting 1/8" diameter router bits.
- Lightweight, non-marring composite fixed base allows for 90° cuts. Base offers easy height adjustment.
- Safety-lock throttle lever is included.
- Front exhaust directs chips away from cutter.
- Spindle lock allows one-wrench cutter changing.
- Includes guide rails, ideal for use on glue seams.



Router Bit Not Included

Model Number	Motor hp (W)	Motor RPM	Sound Level	Maximum Air Flow SCFM (L/Min)	Hose I.D. Size Inch (mm)	Air Inlet Thread	Spindle Thread	Weight Pound (kg)	Base Size Inch (mm)	Height Inch (mm)
51330	.7 (522)	20,000	82 dB(A)	34 (963)	3/8 (10)	1/4" NPT	3/8"-24 Male	2.5 (1.1)	3-1/4 (83) x 3-1/2 (89)	8-1/4 (210)

**Tune-Up Kit: No. 96529** • Additional Specifications: Air Pressure 90 PSIG (6.2 Bar) • Collet Depth 1-5/8" (41 mm) • Max. Cutter Dia. 1-1/8" (29 mm)



# Dynabrade Trim Routers

## Air-Powered Tool for Routing Applications

### 1 hp (744 W) Trim Routers

- Ideal for countless routing applications, on surfaces such as hardwoods and softwoods, cabinets, casework, doors, panels, countertops, laminates, displays and more!
- 1 hp air motor is **governor-controlled** to maintain consistent speed under load.
- Lightweight thermal-insulated tool housing is ergonomically designed for operator comfort.
- Each model includes 1/4" collet, for accepting optional 1/4" router bits.
- Safety-lock throttle lever prevents accidental tool startup, for enhanced workplace safety.

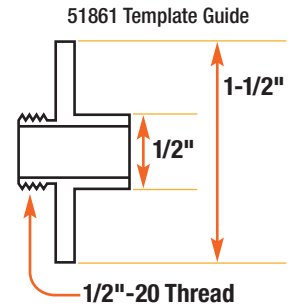

### Model 51860 – Complete Trim Router

#### 20,000 RPM, Rear Exhaust

- Tool includes router nose assembly and 51861 template guide (with 1/2" dia. base). Nose assembly and template guide are nickel-plated for added durability.
- Allows quick adjustment of trim housing depth. Two wrenches included.



### 51818 – Trim Router Replacement Motor

#### 20,000 RPM, Rear Exhaust

- Easy motor replacement for most popular 1 hp Trim Router tools!
- Motor includes adapter (1-3/8"-18 male thread), for use with existing inventories of template guides.



### Model 51865 – Complete Trim Router

#### 20,000 RPM, Front Exhaust

- Tool includes router nose assembly and 51861 template guide (with 1/2" dia. base). Nose assembly and template guide are nickel-plated for added durability.
- Allows quick adjustment of trim housing depth. Two wrenches included.



### 51819 – Trim Router Replacement Motor

#### 20,000 RPM, Front Exhaust

- Easy motor replacement for most popular 1 hp Trim Router tools!
- Motor includes adapter (1-3/8"-18 male thread), for use with existing inventories of template guides.



Model Number	Motor hp (W)	Motor RPM	Sound Level	Maximum Air Flow SCFM (L/Min)	Collet	Air Inlet Thread	Hose I.D. Inch (mm)	Weight Pound (kg)	Length Inch (mm)	Height Inch (mm)
51860	1 (749)	20,000	80 dB(A)	44 (1,256)	1/4"	3/8" NPT	3/8 (10)	2.7 (1.2)	10.9 (277)	1.9 (48)
51818	1 (749)	20,000	80 dB(A)	44 (1,256)	1/4"	3/8" NPT	3/8 (10)	1.9 (.9)	6.4 (163)	1.9 (48)
51865	1 (749)	20,000	84 dB(A)	44 (1,256)	1/4"	3/8" NPT	3/8 (10)	2.6 (1.2)	9.7 (246)	1.9 (48)
51819	1 (749)	20,000	84 dB(A)	44 (1,256)	1/4"	3/8" NPT	3/8 (10)	1.8 (.9)	7.2 (182)	1.9 (48)

Tune-Up Kit: No. 96532 • Additional Specifications: Air Pressure 90 PSIG (6.2 Bar)

# .7 hp (522 W) Vacuum Routers

**For Connection to Central Vacuum System**  
**Unique Vacuum Shroud Captures Contaminants**

- Vacuum Router is ideal for chamfers and roundover cuts on hardwoods, softwoods, solid surfaces and plastics. Great for laminate trimming, surface planing, beveling and cornering.

- Includes 1" vacuum port, for easy connection to external central vacuum system. Efficiently captures dust and debris as tool is run.
- Tool accepts optional high-speed router bits with 1/4" diameter shank capacity. Non-marring composite base.

## 3-1/2" (89 mm) Base Model

**Model 51332**  
 .7 hp (522 W), 20,000 RPM

Includes 94300 Composite Dynaswivel® Air Line Connector (both models)

Safety-lock lever is included (both models)

Includes 08054 Insert, for enhanced source capture (both models)

Adjustable roller guide ensures consistent cut path on edge work



Model 51332

## 4" (102 mm) Base Model

**Model 51333**  
 .7 hp (522 W), 20,000 RPM

Extended rear exhaust muffler for reduced sound levels (both models)

Two handles for added support and ease of use

4" (102 mm) dia. Composite Base offers enhanced stability



Model 51333

1" Dia. Vacuum Port

Model Number	Motor hp (W)	Motor RPM	Sound Level	Maximum Air Flow SCFM (L/Min)	Collet Size	Air Inlet Thread	Weight Pound (kg)	Length Inch (mm)	Height Inch (mm)
51332	.7 (522)	20,000	79 dB(A)	37 (1,048)	1/4"	1/4" NPT	2.6 (1.2)	11 (282)	3.5 (89)
51333	.7 (522)	20,000	79 dB(A)	37 (1,048)	1/4"	1/4" NPT	3.3 (1.5)	11 (282)	4 (102)

**Tune-Up Kit: No. 96259** • Additional Specifications: Air Pressure 90 PSIG (6.2 Bar)

# Dynabrade.com

**Now Available in NINE Languages!**

- **English**
- **German** (Deutsch)
- **Turkish** (Türkçe)
- **Spanish** (Español)
- **Portuguese** (Português)
- **Italian** (Italiano)
- **French** (Français)
- **Simplified Chinese** (简体中文)
- **Russian** (русский)





# “Take-About” Sander

## Air-Powered Abrasive Belt Tool

*Ideal for Surface Leveling, Graining and Finishing!*

### Model 52900

- Heavy-duty 1.3 hp sander (3,500 RPM) powers 3" x 24" abrasive belts, for aggressive material removal on metal and wood.
- Toggle switch offers simple one-step belt tensioning.
- Pistol-grip handle and top control knob allow enhanced operator control. Easily adjustable tracking of abrasive belt.
- Tool works well with non-woven nylon belts.
- Safety-lock throttle lever is included.



Model 52900

Model Number	Motor hp (W)	Motor RPM	Sound Level	Abrasive Belt Size Inch (mm)	Max. Air Flow SCFM (L/Min)	Max. SFPM (SM/Min)	Weight Pound (kg)	Length Inch (mm)	Height Inch (mm)
52900	1.3 (969)	3,500	85 dB(A)	3 (76) W x 24 (610) L	50 (1,416)	2,000 (610)	12.5 (5.7)	13-1/4 (337)	7-1/8 (181)

Additional Specifications: Air Pressure 90 PSIG (6.2 Bar) • Hose I.D. Size 1/2" (13 mm)

# Electric Dynafile® II

## Electric-Powered Abrasive Belt Tool

- Electric Dynafile® II runs coated abrasive and non-woven nylon belts, and is ideal for countless applications on metal, plastic, etc.
- Grind with contact wheel or platen pad. Finish and polish using slack of belt.
- Accepts over 20 Contact Arms, for belts 1/8" to 3/4" wide x 18" long.
- Comfortable switch with “lock on” feature.
- Easily accessible brushes for quick replacement.
- Sanding head pivots 360°, for working in previously inaccessible areas.
- Reversible side handle for operator comfort.
- Tool is double-insulated for safety, and includes electric cord, 8 feet in length.



Model 40610

**Model 40610 – 120 V (AC)**  
**Model 40615 – 220 V (AC)**

**Model 40610 120 V (AC), 11,000 RPM**

**Model 40615 220 V (AC), 11,000 RPM**

- Each tool includes 11203 Contact Arm, for abrasive belts 1/2" wide by 18" long.

**40611 Versatility Kit 120 V (AC)**

**40616 Versatility Kit 220 V (AC)**

- Includes Electric Dynafile® II with 11203 Contact Arm, and two additional arms (11202 and 11204). Also includes eight abrasive belts of various grits, and an assortment of platen pads. All items contained in a durable carrying case.



Model 40611

Model Number	Motor RPM	Maximum Watts Out	Abrasive Belt Size Inch (mm)	Voltage	Current Amps	Phase	Frequency	Weight Pound (kg)	Length Inch (mm)	Height Inch (mm)
40610	11,000	680	1/4-3/4 (6-19) W x 18-24 (457-610) L	120 V (AC)	6	1	50/60 Hz	5 (2.3)	19 (483)	5-1/2 (140)
40615	11,000	680	1/4-3/4 (6-19) W x 18-24 (457-610) L	220 V (AC)	3,4	1	50/60 Hz	5 (2.3)	19 (483)	5-1/2 (140)

**Plug Type:** 40610 – USA, 40615 – European Universal • Additional Specifications: Maximum 2,520 SFPM (768 SM/Min)

# Dyninger

## Air-Powered Abrasive Finishing Tool

### Sand, Defuzz, Blend, Scuff, Denib

- Excellent for blending and scuffing sealer coatings on contours and flat surfaces. Whitewood sand raised panels, turnings, moldings and hard-to-reach areas.
- Defuzz wooden grid pattern panels and denibbing raised grain.
- Great for light deburring of metal.

### Model 52060 950 RPM

- High torque air motor includes arbor (1" dia.) for mounting up to six coated abrasive stars, 8" diameter with 1" center hole (sold separately).

### 52061 Basic Versatility Kit

- 52060 Dyninger with 1" dia. arbor.
- 93245 Six Coated Abrasive Stars (120 grit).
- 93251 Six Coated Abrasive Stars (320 grit).
- 52031 Abrasive Dressing Plate.

### 52062 Deluxe Versatility Kit

- 52060 Dyninger with 1" dia. arbor.
- 93245 Six Coated Abrasive Stars (120 grit).
- 93251 Six Coated Abrasive Stars (320 grit).
- 52031 Abrasive Dressing Plate.
- 80020 Universal Tool Bench Mount.
- 95745 Speed Control.

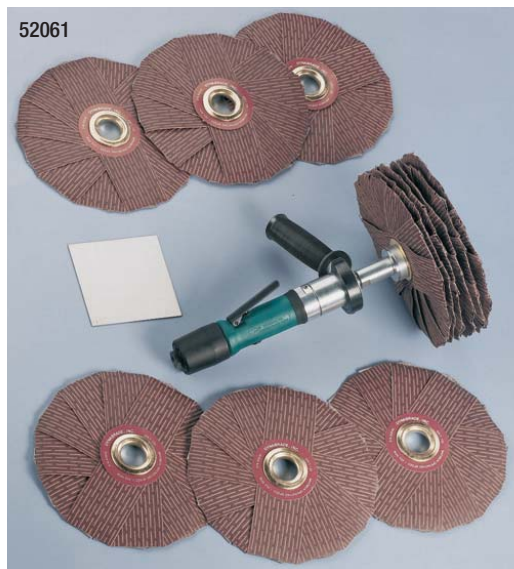

Model Number	Motor hp (W)	Motor RPM	Sound Level	Maximum Air Flow SCFM (L/Min)	Wheel Arbor Diameter	Air Inlet Thread	Tool Thread	Weight Pound (kg)	Length Inch (mm)	Height Inch (mm)
52060	.4 (298)	200-950	82 dB(A)	22 (623)	5/8" or 1"	1/4" NPT	3/8"-24 Male	3.7 (1.7)	11-1/8 (283)	2-3/4 (70)

**Tune-Up Kit: No. 96173** • Additional Specifications: Hose I.D. Size 1/4 (6 mm) • Air Pressure 90 PSIG (6.2 Bar)



# Lightweight Dyninger

## Air-Powered Abrasive Finishing Tool

### Sand, Defuzz, Blend, Scuff, Denib

- For whitewood/sealer sanding, light deburring of metal, or fabrication and finishing of composite surfaces.
- Excellent for use on wooden parts, moldings, raised panels and intricate profiles. Eliminates raised grain and removes loose fibers when whitewood sanding as well as scuffing sealer coats.
- Tool includes air-flow control Dynaswivel® fitting for maximum tool maneuverability and control.



### Spindle-Mount

- Mount 4" diameter spindle-mount abrasive sanding stars with 1/4" shank, or Eyelet Sanding Stars. (Stars sold separately.)

**Model 52050** 0-3,200 RPM, 1/4" Collet

**Model 52051** 0-3,200 RPM, 6 mm Collet



### Arbor-Mount

**Model 52052** 0-3,200 RPM

- For running arbor-mount abrasive stars or Dynacushion® wheel.
- Includes 12980 Arbor (1/2" diameter) for mounting up to five 4" diameter arbor-mount sanding stars (1/2" center hole). Arbor includes spacers to be used between the stars for added flexibility. (Stars sold separately.)



Model Number	Motor hp (W)	Motor RPM	Sound Level	Maximum Air Flow SCFM (L/Min)	Hose I.D. Size Inch (mm)	Air Inlet Thread	Tool Thread	Weight Pound (kg)	Length Inch (mm)	Height Inch (mm)
52050	.4 (298)	0-3,200	81 dB(A)	22 (623)	1/4 (6)	1/4" NPT	3/8"-24 Male	2.2 (1.0)	9-1/4 (235)	1-5/8 (40)
52051	.4 (298)	0-3,200	81 dB(A)	22 (623)	1/4 (6)	1/4" NPT	3/8"-24 Male	2.2 (1.0)	9-1/4 (235)	1-5/8 (40)
52052	.4 (298)	0-3,200	81 dB(A)	22 (623)	1/4 (6)	1/4" NPT	3/8"-24 Male	2.2 (1.0)	8-3/4 (222)	1-5/8 (40)

**Tune-Up Kit: No. 96173** • Additional Specifications: Air Pressure 90 PSIG (6.2 Bar)

# 3" Palm-Style Buffer

## Air-Powered Buffing Tool

### Repair Sanding Scratches on Solid Surface

- Excellent for buffing and polishing fiberglass, plastics and other materials.
- Low profile housing; rear exhaust; lever throttle.

### Model 57550 3" Diameter, 2,400 RPM

- Includes 50125 rigid 3" backing pad, terry cloth pad and wool pad.

### 57553 Versatility Kit

- Efficiently repair scratches on solid surface.
- Quick, simple spot repair on painted surfaces.
- Mini Random Orbital Sander; 3" Buffer; 3-1/2" Disc Sander.
- Includes: 2,400 RPM basic tool; 54476 Mini-Orbital Head; 3" backing pad; 1-1/4" and 3-1/2" dia. vinyl-face pads; 3" dia. terry cloth bonnet, wool bonnet and foam "flat face" pad; 95723 Finesse It Creme; 95727 Dynabrade Glaze, sample discs and sample abrasive pack.

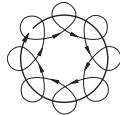

**3/16"**  
Dia. Orbit

(with 54476 Head Attached)



**Rotary**  
Motion



Model Number	Motor hp (W)	Motor RPM	Sound Level	Maximum Air Flow SCFM (L/Min)	Hose I.D. Size Inch (mm)	Air Inlet Thread	Tool Thread	Weight Pound (kg)	Length Inch (mm)	Height Inch (mm)
57550	.25 (186)	2,400	79 dB(A)	18 (510)	1/4 (6)	1/4" NPT	1/4"-20 Male	1.9 (.9)	5-3/8 (137)	4-1/4 (108)

**Tune-Up Kit: No. 96107** • Additional Specifications: Air Pressure 90 PSIG (6.2 Bar)

# 3" Angle-Head Buffer

## Air-Powered Buffing Tool

### Repair Sanding Scratches on Solid Surface

### Model 49440 3" Diameter, 3,200 RPM

- Tool comes mounted with 54021 Adapter (1/4"-20 male thread).
- Governor-controlled motor maintains speed under load.
- Includes 50120 Hook-Face Pad (3" diameter), which mounts directly to 54021 Adapter.
- Also includes 90027 Terry Cloth Bonnet and 90028 Wool Buffing Bonnet.
- Extended rear exhaust muffler, safety-lock lever, rotary action.

### Model 49403 Versatility Kit

- Repair dust nibs and scratches on clearcoat.
- Includes: 3,200 RPM air tool, 54028 Random Orbital Sanding Head, two sanding pads, 50120 Hook 'n Loop Pad for bonnets, 54021 Adapter, wool and terry cloth bonnets, 95723 Finesse Sanding Creme, 95727 Dynabrade Glaze, assorted wrenches and sample abrasives.

Note: Optional 54585 Side Handle Assembly available.



**3/16"**  
Dia. Orbit

(with 54028 Head Attached)

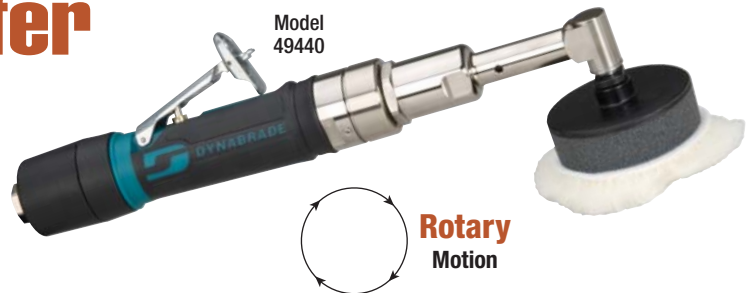

**Rotary**  
Motion



Model Number	Motor hp (W)	Motor RPM	Sound Level	Maximum Air Flow SCFM (L/Min)	Hose I.D. Size Inch (mm)	Air Inlet Thread	Tool Thread	Weight Pound (kg)	Length Inch (mm)	Height Inch (mm)
49440	.4 (298)	3,200	79 dB(A)	26 (736)	1/4 (6)	1/4" NPT	1/4"-28 Female	1.9 (.9)	13 (331)	2.6 (67)

**Tune-Up Kit: No. 96541** • Additional Specifications: Air Pressure 90 PSIG (6.2 Bar)



# 7° Offset Buffers

## Air-Powered Buffing Tool

### Polish Fiberglass, Plastics and More!

- 7° offset ergonomic design for control and comfort.
- High torque planetary-gear air motor; muffler reduces sound level.
- Standard rotary action. Rear exhaust.

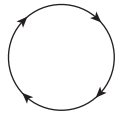

**Rotary Motion**

### 3" Diameter

- Includes 50126 Hook-Face Pad, 90027 Terry Cloth Bonnet and 90028 Wool Buffing Bonnet.
- 3/8"-24 Male Thread.

**Model 51400 3,200 RPM**

**Model 51402 3,600 RPM**

**Model 51401 5,000 RPM**

### 51405 Versatility Kit

- Includes: 51400 air tool; 3" Hook-Face backing pad, terry cloth bonnet, wool bonnet and foam "flat face" pad; Dynabrade Finesse-It Creme; Dynabrade Glaze and 14 mm open-end wrench (not shown).



51405



Model 51400



Model 51430

### 5" Diameter

**Model 51430 3,200 RPM**

- Includes 50147 Hook-Face Pad and 90040 Foam "Flat Face" Buffing Pad.
- Shown with optional 13141 Side Handle/Collar Assembly.
- 3/8"-24 Male Thread.

Model Number	Motor hp (W)	Motor RPM	Sound Level	Maximum Air Flow SCFM (L/Min)	Hose I.D. Size Inch (mm)	Air Inlet Thread	Tool Thread	Weight Pound (kg)	Length Inch (mm)	Height Inch (mm)
51400	.4 (298)	3,200	77 dB(A)	24 (680)	3/8 (10)	1/4" NPT	3/8"-24 Male	1.7 (.8)	8-3/4 (222)	4-1/4 (108)
51401	.4 (298)	5,000	75 dB(A)	24 (680)	3/8 (10)	1/4" NPT	3/8"-24 Male	1.7 (.8)	8-3/4 (222)	4-1/4 (108)
51402	.4 (298)	3,600	76 dB(A)	24 (680)	3/8 (10)	1/4" NPT	3/8"-24 Male	1.7 (.8)	8-3/4 (222)	4-1/4 (108)
51430	.4 (298)	3,200	77 dB(A)	24 (680)	3/8 (10)	1/4" NPT	3/8"-24 Male	2.4 (1.1)	9-3/4 (248)	4-1/2 (114)

**Tune-Up Kit: No. 96174** • Additional Specifications: Air Pressure 90 PSIG (6.2 Bar)

# 6"-8" Dia. Buffer

## Air-Powered Buffing Tool

### Achieve Fine Finish on Many Surfaces

- Tool accepts large diameter polishing pads for maximum surface coverage. Polish MORE area in LESS time!
- Long handle design and reversible side handle offer excellent operator comfort and control, especially in vertical positions.



- .7 hp air motor, running at 2,500 RPM.
- Standard safety-lock lever.
- Backup pad and polishing bonnet each sold separately.

**Model 51459** 5/8"-11 Male Thread

**Model 51458** M14 x 2 Male Thread

*Shown with optional 50853 Backup Pad and optional 90082 Polishing Pad.*

Model Number	Motor hp (W)	Motor RPM	Maximum Air Flow SCFM (L/Min)	Spindle Thread	Hose I.D. Size Inch (mm)	Air Inlet Thread	Weight Pound (kg)	Length Inch (mm)	Height Inch (mm)
51459	.7 (522)	2,500	27 (765)	5/8"-11 Male	3/8 (10)	1/4" NPT	5.3 (2.4)	11-3/4 (301)	4 (102)
51458	.7 (522)	2,500	27 (765)	M14x2 Male	3/8 (10)	1/4" NPT	5.3 (2.4)	11-3/4 (301)	4 (102)

**Tune-Up Kit:** 51459 – No. 96672; 51458 – No. 96532 • Additional Specifications: Air Pressure 90 PSIG (6.2 Bar)

# Electric Buffer

## Electric-Powered Buffing Tool

### Model 51580

- Variable speed trigger with adjustable 0-3,000 RPM roller dial for optimum performance and control. Desired RPM can be locked with speed-lock button.
- Rotating Trigger Handle with One-Touch Switch! Handle can be adjusted to any position for optimum comfort! One-touch switch allows easy adjustment.
- Top-quality brushes last longer, and are externally accessible for increased productivity.
- Versatile rubberized side handle mounts in three positions, for ultimate versatility.
- 11-amp motor for power!
- Long 8-foot electric cord is made of oil-resistant rubber, and stays flexible when cold.
- Accepts a variety of pads & buffs. Shown with 50853 Backing Pad and 90082 Polishing Pad (7" diameter), each sold separately.



*One-touch switch easily allows new trigger handle to rotate 180° into any position.*

Model Number	Motor RPM	Maximum Watts Out	Voltage	Current Amps	Phase	Frequency	Spindle Thread	Weight Pound (kg)	Length Inch (mm)	Height Inch (mm)
51580	0-3,000	1,305	120 V (AC)	11	1	60 Hz	5/8"-11	7.8 (3.5)	17 (432)	5-1/4 (133)



# “Raptor Vac” Portable Vacuums



**Aggressively Capture Workplace Dust & Debris**  
**Electric & Pneumatic Units in Various Configurations**

## M-Class Models *Electric*

- Two systems available: Non-Conductive Polycarbonate (left), and Conductive Stainless Steel.
- Variety of electrical configurations offered, for worldwide use.
- Connects to optional Vacuum Cart. See page 36 for details.

Model 61400



120 V (60 Hz)

Model 61401



120 V (60 Hz)

## Model 61430 *Electric*

- Division 2, 120 V (60 Hz)

## Model 61431 *Electric*

- ATEX Cat. 3 for Zone 22, 230 V (50 Hz)

Model 61430



Model 61440



## Model 61440 *Pneumatic*

- Division 2

## Model 61441 *Pneumatic*

- ATEX Cat. 3 for Zones 2 & 22

## Model 61450 *Electric*

- Division 1, 120 V (50/60 Hz)

## Model 61451 *Electric*

- ATEX Cat. 2 for Zones 1 & 21, 230 V (50/60 Hz)

Model 61450



## Model 61465 *Pneumatic*

- Division 1

## Model 61466 *Pneumatic*

- ATEX Cat. 2 for Zones 1 & 21

Model 61465



## Model 61461 *Electric*

- Division 1 Immersion Separator, 120 V (50/60 Hz)

## Model 61462 *Electric*

- ATEX Cat. 2 for Zones 1 & 21 Immersion Separator, 230 V (50/60 Hz)

Model 61461



Model 61463



## Model 61463 *Pneumatic*

- Division 1 Immersion Separator

## Model 61464 *Pneumatic*

- ATEX Cat. 2 for Zones 1 & 21 Immersion Separator

**Ideal for collecting aluminum, magnesium and titanium dust!**

**Ideal for collecting aluminum, magnesium and titanium dust!**



**See Next Page for Additional Vacuum Systems!**



**WATCH Raptor Vac™ Video!**



# Additional Vacuum Systems



## “Raptor Vac” Backpack Style Portable Vacuum *Pneumatic*

- Lightweight unit includes backpack harness for great portability!
- Ideal in tight areas where larger vacuum would be cumbersome.



61472 – North America • 61473 – Europe

## “Raptor Vac” Wall-Mount Style Portable Vacuum *Pneumatic*

- Includes brackets for mounting to workplace wall or to Vacuum Cart (as shown).
- Excellent choice for smaller individual work cells!



61470 – North America • 61471 – Europe

## Vacuum / Accessory Cart

- Portable Vacuum locks into 61483 Cart.
- Accepts M-Class Vacuums (page 35) or Wall-Mount Vacuum, sold separately.
- Cart includes lockable storage shelves, for tools, abrasives and hoses.



61483 Cart with Hoses & Tools

61483 Cart with 61400 Vacuum & Tools

## Downdraft Sanding Tables

*Eliminate Airborne Dust and Contaminants While Sanding For Use with Non-Metallic Surfaces Only*

### Standard Duty Tables

**Model 64201** Working Area of 33" W x 41" L

**Model 64699** Working Area of 33" W x 60" L

**Model 64700** Working Area of 36" W x 72" L

- Ideal for use with vacuum or non-vacuum tools.
- Dual filtration – accepts MERV 8 pleated paper filters, 20" W x 25" L. (Models 64201 and 64699 include two filters; model 64700 includes three.)
- Each model also includes one pre-filter blanket.
- Rhino Linings® coated tabletop surface is durable and anti-slip.
- 5" diameter casters allow easy maneuverability of table; two handy storage compartments for tools and accessories; two convenient dust-tight electric outlets.



Model 64700



Model 64657

### Heavy Duty Table

**Model 64657** Working Area of 48" W x 96" L

- Includes eight 20" x 25" paper filters (64658) and four 16" x 25" paper filters (64659).
- Dual filtration – pre-filter blanket and MERV 8 paper filters.
- Up to 70% more filter area than competitive brands.
- High quality reverse incline blowers. Heavy duty TEFC twin electric motors.
- Base unit is all-metal construction with CNC milled 3/4" MDF tabletop.
- Anti-static, anti-slip mat (64970) is included, and available separately. Optional 5" diameter casters also available.

**Ask About Many Voltage Formats Available!**



# Dynaswivel® Air Line Connectors

Never Fight an Air Tool Again! For Use with Most Air Tools



- The Dynaswivel® is a “universal-joint” that connects portable air tools to an air line.
- It improves tool maneuverability, minimizes operator fatigue and extends hose life.
- Patented; works great on air tools or paint guns.

## Non-Marring Composite Construction

### Double Pivot

- Swivels 360° AT TWO PIVOT POINTS allowing the air hose to drop directly to the floor while providing superb tool handling.

### Double Pivot, Flow Control

- Swivels 360° AT TWO PIVOT POINTS allowing the air hose to drop directly to the floor while providing superb tool handling.
- Fingertip air-flow control dial.

### Display Pak (96177)

- Includes countertop display box and ten 94300 Dynaswivel® Connectors.



Part Number	Thread Size	Flow Control	Air Flow Range SCFM (L/Min)	Weight oz. (kg)
94300*	1/4" NPT	No	up to 33 (935)	2.15 (.06)
94407**	1/4" NPT	Yes	up to 46 (1,303)	2.40 (.08)

\*USA Government National Stock Number 4730012932930

\*\*USA Government National Stock Number 4730015023159

## Aluminum and Stainless Steel Construction

### Single Pivot

- Right angle “single-pivot” swivels 360° at one location.
- Designed to permit air hose to extend horizontally away from tool while allowing 360° tool maneuverability.
- Great for stationary equipment.



Part Number	Thread Size	Air Flow Range SCFM (L/Min)	Weight lb. (kg)
95590	1/4" NPT	up to 25 (708)	0.11 (0.05)
95591	3/8" NPT	26-45 (736-1,275)	0.26 (0.12)
95592	1/2" NPT	46-65 (1,303-1,841)	0.46 (0.21)

## Aluminum and Stainless Steel Construction

### Double Pivot

- Swivels 360° AT TWO PIVOT POINTS allowing the air hose to drop directly to the floor while providing superb tool handling.

### Double Pivot, Flow Control

- Swivels 360° AT TWO PIVOT POINTS allowing the air hose to drop directly to the floor while providing superb tool handling.
- Finger-tip air-flow control dial.



Part Number	Thread Size	Flow Control	Air Flow Range SCFM (L/Min)	Weight lb. (kg)
95852	1/8" Male x 25 1/4" NPT Female	No	up to 25 (708)	0.18 (0.08)
95460*	1/4" NPT	No	up to 25 (708)	0.20 (0.09)
95734	1/4" NPT	Yes	up to 25 (708)	0.24 (0.11)
95461	3/8" NPT	No	26-45 (736-1,275)	0.40 (0.18)
95462	1/2" NPT	No	46-65 (1,303-1,841)	0.80 (0.36)
95690	3/4" NPT	No	above 65 (1,840)	1.50 (0.68)

## Ball-Swivel Plug

### Part No. 97016

Plug “swivels” for great tool maneuverability!

- 97016 Ball-Swivel Plug offers 53° conical range of motion, for added tool maneuverability and operator comfort.
- A natural fit with Dynabrade palm-style Random Orbital Sanders!
- Ported plug design allows air flow of up to 74 SCFM (2,095 L/Min).
- Maximum air pressure of 90 PSIG (6.2 Bar).

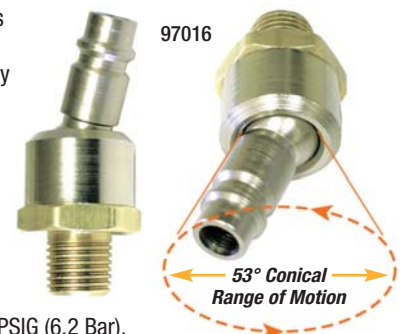

# DynaJet In-Line Blow Gun

## Clean Off Work Surfaces Without Disconnecting

### Part No. 94467 Safety Tip Design

- Only connect once... permanently mounts between coupler and air hose to purge air line of water and contaminants before starting up air tools.
- Durable aluminum construction, weighs only 2 oz. (0.06 kg).
- Reduces line pressure down to 30 PSIG (2 Bar).
- Meets O.S.H.A. requirements of special relief hole in nozzle, which limits pressure to 30 PSIG (2 Bar) when dead-ended and used on an air line of 150 PSIG (10.3 Bar) or less.



Part Number	Thread Size	Weight	Recommended Air Flow Range SCFM (L/Min)
94467	1/4" Female NPT	0.06 kg	up to 35 SCFM (991 L/Min)

10.3 Bar (150 PSIG) maximum

### Proper Installation for DynaJet Blow Gun Connection

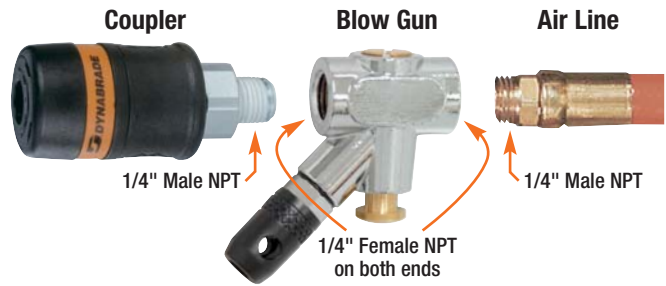

# Filter-Regulator-Lubricator

## Cost-Effective Maintenance for Air Supply Systems

### Filter-Regulator-Lubricator

- Unit has modular connections with mounting brackets for easy installation.

Part Number	Air Inlet Thread
10681	1/2" NPT



### Filter-Regulator

- Unit has modular connections with mounting brackets for easy installation.

Part Number	Air Inlet Thread
10677	1/2" NPT



### Regulator-Lubricator

- Unit has modular connections with mounting brackets for easy installation.

Part Number	Air Inlet Thread
10679	1/2" NPT



### FRL Flow Characteristics

Air Flow SCFM (L/Min)	Pressure Drop Across FRL PSI (Bar)
15 (425)	2.0 (.14)
30 (850)	3.0 (.21)
45 (1,274)	6.0 (.41)
60 (1,699)	7.0 (.48)
75 (2,124)	8.0 (.55)

### Filter

- Five-micron filter element is standard.
- Manual push-button drain easily discharges contaminants.

Part Number	Air Inlet Thread
10671	1/2" NPT



### Regulator

- Compensation built into unit responds faster to changes in incoming pressure and flow.
- Built-in PSI pressure dial gauge.

Part Number	Air Inlet Thread
10673	1/2" NPT



### Lubricator

- Built-in check valve permits tool to be filled with oil without having to turn off air pressure.
- Adjustable oil drop to meter amount of oil into air system.

Part Number	Air Inlet Thread
10675	1/2" NPT



Each unit includes two bushings for easy conversion to 3/8" NPT.

Additional Specifications: Maximum Operating Pressure 145 PSIG.



# Air Line Assemblies

Cost-Effective Air Tool Connections • Flexible and Swivel-Style

## Flexible Air Lines – 1/4" I.D.

Part Number	Length Feet (Meters)	Line I.D.	Fittings Included
95580	28" (711 mm)	1/4"	Female (1/4") / Male (1/4")
95361	5 (1.5)	1/4"	Female (1/4") / Male (1/4")
95816	10 (3)	1/4"	Female (1/4") / Male (1/4")
95807	Specify	1/4"	not included*

\*Installed fittings may be ordered: 95938 – Female (1/4") / Male (1/4")



## Flexible Air Lines – 3/8" I.D.

Part Number	Length Feet (Meters)	Line I.D.	Fittings Included
95771	40" (1,016 mm)	3/8"	Female (1/4") / Male (1/4")
96339	5 (1.5)	3/8"	Female (1/4") / Male (1/4")
11292	8 (2.5)	3/8"	Male (1/4") / Male (1/4")
96323	10 (3)	3/8"	Female (1/4") / Male (1/4")
95101	Specify	3/8"	not included*

\*Fittings may be ordered separately.



## Flexible Air Line – 1/2" I.D.

Part Number	Length Feet (Meters)	Line I.D.	Fittings Included
95870	5 (1.5)	1/2"	Female (1/2") / Male (1/2")



## Swivel Air Lines – 1/4" O.D.

Part Number	Length Feet (Meters)	Line O.D.	Fittings Included
96217	3 (0.9)	1/4"	Female (1/4") / Male (1/4")
96218	3 (0.9)	1/4"	Female (1/4") / Male (1/8")
96219	6 (1.8)	1/4"	Female (1/4") / Male (1/4")
96220	6 (1.8)	1/4"	Female (1/4") / Male (1/8")
96221	Specify	1/4"	not included*

\*Fittings may be ordered separately.

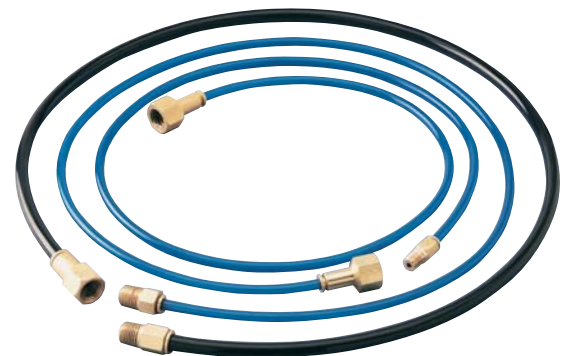

## Swivel Air Lines – 3/8" O.D.

Part Number	Length Feet (Meters)	Line O.D.	Fittings Included
96222	3 (0.9)	3/8"	Female (1/4") / Male (1/4")
96223	6 (1.8)	3/8"	Female (1/4") / Male (1/4")
96224	Specify	3/8"	not included*

\*Fittings may be ordered separately.

# Couplers and Coupler/Plug Assemblies

Provide Maximum Air Flow to Tools • Plugs Also Sold Separately

## Steel and Brass Couplers

- Durable nickel-plated steel and brass construction.
- Single action quick-connect by just inserting plug into coupler. Pull back on sleeve of coupler for quick disconnect.



Coupler Body Size	Part Number	Thread Size NPT	Air Flow Range SCFM (L/Min)
1/4"	95674	1/4" Female	Up to 74 (2,095)
	95684	1/4" Male	
3/8"	98261	3/8" Female	Up to 138 (3,900)
	98262	3/8" Male	
1/2"	98269	1/2" Female	Up to 138 (3,900)
	98270	1/2" Male	

## Composite-Style Couplers

- Composite-style design provides maximum air flow to tools.
- Heavy duty construction.
- Easy connect/disconnect by single push-button action.
- Shock-proof, low-vibration, crush-resistant.
- Lightweight 1.4 oz. (0.04 kg), non-marring composite material.



Coupler Body Size	Part Number	Thread Size NPT	Air Flow Range SCFM (L/Min)
1/4"	94960	1/4" Female	Up to 54 (1,529)
	94980	1/4" Male	

## Safety Couplers

- Unique "Two Step" Safety Disconnect System releases air pressure before tool is disconnected.
- Engineered to minimize air leakage and eliminates "hose whip."
- Aerodynamically-designed valve improves air flow to tool.
- Ergonomically designed for easy one-hand operation.
- Advanced anti-static composite and stainless steel construction; cannot rust or corrode.
- Impact resistant with non-scratch surface.
- Conforms to ISO 4414 standard, and these specifications: 7.2/7.4 European full flow profile.



Coupler Body Size	Part Number	Thread Size NPT	Air Flow Range SCFM (L/Min)
1/4"	97566	1/4" Female	Up to 55 (1,558)
	97567	1/4" Male	

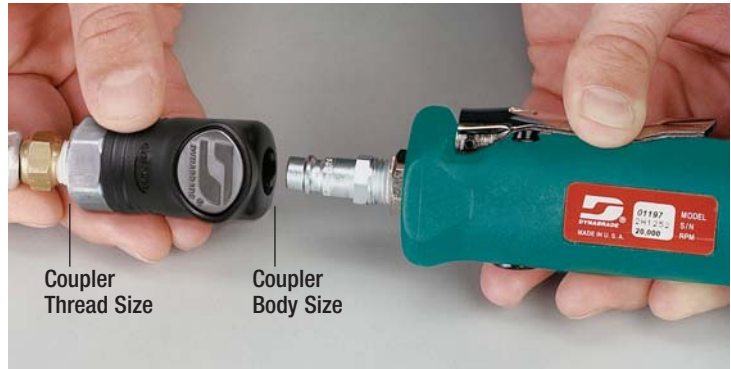

## Coupler/Plug Assemblies

- Assemblies include one coupler and one plug.
- Maximum working pressure: 150 PSIG (10 Bar).
- Temperature Range: -4°F to 212°F (-20°C to 100°C).



## Plugs with Steel and Brass Couplers

Coupler Body Size	Part Number	Coupler Thread Size (NPT)	Plug Body Size	Plug Thread Size (NPT)	Air Flow Range SCFM (L/Min)
1/4"	95676	1/4" Female	1/4"	1/4" Male	Up to 74 (2,095)
	95850	1/4" Female	1/4"	1/4" Female	
	95685	1/4" Male	1/4"	1/4" Male	
	95851	1/4" Male	1/4"	1/4" Female	
3/8"	98265	3/8" Female	3/8"	3/8" Male	Up to 138 (3,900)
	98266	3/8" Female	3/8"	3/8" Female	
	98267	3/8" Male	3/8"	3/8" Male	
	98268	3/8" Male	3/8"	3/8" Female	
1/2"	98273	1/2" Female	1/2"	1/2" Male	Up to 138 (3,900)
	98274	1/2" Female	1/2"	1/2" Female	
	98275	1/2" Male	1/2"	1/2" Male	
	98276	1/2" Male	1/2"	1/2" Female	

## Plugs with Black Composite-Style Couplers

Coupler Body Size	Part Number	Coupler Thread Size (NPT)	Plug Body Size	Plug Thread Size (NPT)	Air Flow Range SCFM (L/Min)
1/4"	94990	1/4" Female	1/4"	1/4" Male	Up to 54 (1,529)
	94991	1/4" Female	1/4"	1/4" Female	
	94992	1/4" Male	1/4"	1/4" Male	
	94993	1/4" Male	1/4"	1/4" Female	

## Plugs with Safety Couplers

Coupler Body Size	Part Number	Coupler Thread Size (NPT)	Plug Body Size	Plug Thread Size (NPT)	Air Flow Range SCFM (L/Min)
1/4"	97572	1/4" Female	1/4"	1/4" Male	Up to 55 (1,558)
	97573	1/4" Female	1/4"	1/4" Female	
	97574	1/4" Male	1/4"	1/4" Male	
	97575	1/4" Male	1/4"	1/4" Female	



# Vacuum Conversion Kits

## For Dynabrade Random Orbital Sanders

- Pad diameter determines which kit is right for your tool.
- Conversion Kit allows user to change tool into desired vacuum configuration.



Pad Diameter	Converts Tool To	Kit Part Number
3-1/2" (89 mm)	Self-Generated Vacuum	57118
3-1/2" (89 mm)	Central Vacuum	57119
5" (127 mm)	Self-Generated Vacuum	57120
5" (127 mm)	Central Vacuum	57121
6" (152 mm)	Self-Generated Vacuum	57122
6" (152 mm)	Central Vacuum	57123

# Vacuum Hose Swivel Adapters

## SWIVELS for Tool Maneuverability

- Ideal for Dynabrade Random Orbital Sanders.
- 1" (25 mm) connection to tool.

### Part No. 96572 1" Swivel Adapter

- 1" (25 mm) connection to vacuum hose.

### Part No. 96573 1-1/4" Swivel Adapter

- 1-1/4" (32 mm) connection to vacuum hose.



# Vacuum Hose Assemblies/Accessories

## Vacuum Hose/Air Line Assembly

### Part No. 95820

1" (25 mm) Dia. x 10' (3 m) Long

- For use with Dynabrade Random Orbital Sanders.
- 95709 Flex Hose: 1" (25 mm) x 10' (3-1/4 m) long with cuffs.
- 95816 Air Line: 1/4" (6 mm) dia. x 11' (3.375 m) long
- 95362 Rubber Connectors.



## Vacuum Hose Cover

### Part No. 95986

5' (1.5 m) Long Cloth Cover

- Covers air line and vacuum hose (not included).
- Eliminates damage from hose dragging on the work surface.



## Rubber Connectors

### Part No. 95362 (5/pkg.)

- Used to strap tool air line to tool's vacuum hose for easy "all-in-one" maneuverability.



# Dust Collection Receptacles & Self-Contained Dust Collection Systems

Easily Attach to Dynabrade Self-Generated Vacuum Tools

## Mini-Reusable Felt Bag

### Part No. 50694

- 11" (279 mm) long x 3" (76 mm) wide. End opens up - no need to remove bag from tool when emptying.
- One-micron filter rating. Bag traps over 99% of vacuum particles one micron or larger.



## Reusable Felt Bags

- 14-1/2" (368 mm) long x 7-1/2" (191 mm) wide.
- One-micron filter rating. Bag traps over 99% of vacuum particles one micron or larger.



### Part No. 50683 Hook-Face Closure

### Part No. 56304 Zipper-Lock Closure



## Durable Box Receptacle

### Part No. 95575

- A pre-punched hole accepts 1" (25 mm) diameter Dynabrade vacuum hoses.
- Houses paper vacuum bag. Reorder bags in quantities of 400 (50692), or 24 (50693).



## Mini-Flex-Hose System

### Part No. 54284

- 95580 Air Line 1/4" (6 mm) dia. x 28" (711 mm) long.
- 50638 Flex-Hose 1" (25 mm) dia. x 18" (457 mm) long.
- 50694 Mini-Reusable Felt Bag.



## 6' (1.8 m) Long Flex-Hose Systems

### 1" (25 mm) dia. 50682 Flex-Hose

### Part No. 50617

- Includes 50683 Bag with hook-face closure.

### Part No. 56303

- Includes 56304 Bag with zipper-lock closure.

### 1-1/4" (32 mm) dia. 54202 Flex-Hose

### Part No. 54218

- Includes 50683 Bag with hook-face closure.

### Part No. 54219

- Includes 56304 Bag with zipper-lock closure.



## "Bag-in-Box" System

### Part No. 54290

- Includes: 95361 Air Line, 5' (1.5 m) long, 50682 Flex-Hose (1" [25 mm] dia. x 6' [1.8 m] long) and 95575 Durable Box Receptacle (to house bag and store tool).
- Sample paper bag included. Paper bag reorder: 50692 (400/case) or 50693 (24/pkg.)



## "Bag-In-Bag" System

### Part No. 54288

- 50692 Disposable Vacuum Bag fits inside reusable 50697 Mesh-Style Bag, which attaches to operator's belt for added maneuverability.
- Includes: 50682 Flex Hose (1" [25 mm] dia. x 6' [1.8 m] long), 95361 Air Line (1/4" 96 mm dia. x 5' [1.5 m] long) and 94996 Belt Strap.



## HEPA "Bag-In-Bag" System

### Part No. 54500

- Includes 56327 HEPA Bag (.03 micron filtration), which fits inside durable mesh bag. System attaches to operator's belt loop, allowing full mobility.
- HEPA Dust Seal™ securely traps all contents, even as bag is disconnected.
- Also includes 50682 Flex Hose (1" [25 mm] dia. x 6' [1.8 m]), 95361 Air Line (1/4" [6 mm] dia. x 5' [1.5 m]) and 94996 Belt Strap.
- HEPA Bags sold separately, and in 56332 Ten-Pack or 56333 Case (250 Bags).





# Vinyl-Face

# Random Orbital Sanding Pads

## With Dynabrade's Exclusive Single-Piece Hub Design!

- Exclusive single-piece hub design reduces pad vibration and ensures smooth performance.
- PREMIUM URETHANE Sanding Pads are perfectly weight-mated to Dynabrade tools, for achieving consistent **swirl-free finishes**.

Ask for the **ORANGE!**

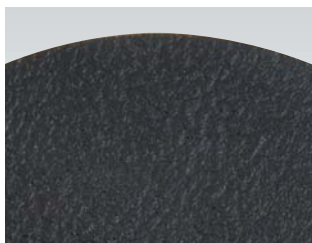

### Vinyl-Face Pads

Ideal for PSA-type disc adhesion. Remove abrasive adhesive paper liner and press abrasive to vinyl-face sanding pad. Quick disc removal.



### Non-Vacuum Pads

High quality backup pad. Weight-mated for smooth running and minimal tool vibration.



### Vacuum Pads

Holes are precisely located to achieve proper alignment with abrasive discs, for optimum vacuum capabilities.



### Channel Vacuum Pads

1/8" (3 mm) deep recessed channel. No need to align abrasive holes with pad holes!

## Non-Vacuum Pads

Pad Diameter	Part Number	Thickness	Density
3" (76 mm)	56084	5/8" (16 mm)	Medium
	56086	5/8" (16 mm)	Soft
3-1/2" (89 mm)	56097	5/8" (16 mm)	Soft
	56098	5/8" (16 mm)	Medium
5" (127 mm)	56102	3/8" (10 mm)	Soft
	56106	3/8" (10 mm)	Medium
	56175	5/8" (16 mm)	Medium
	56185	5/8" (16 mm)	Soft
	56273	1/2" (13 mm)	Extra Soft
6" (152 mm)	56103	3/8" (10 mm)	Soft
	56107	3/8" (10 mm)	Medium
	56177	5/8" (16 mm)	Medium
8" (203 mm)	56187	5/8" (16 mm)	Soft
	56234	3/8" (10 mm)	Medium

3"-6" Pads: 13,000 RPM maximum operating speed; 5/16"-24 male thread. (8" dia. pad mounts with 5 screws. 10,000 RPM max.)



See Sanding Pad Display Packs on Page 46

## Vacuum Pads

Pad Diameter	Part Number	Holes	Thickness	Density
3" (76 mm)*	56084	0	5/8" (16 mm)	Medium
	56086	0	5/8" (16 mm)	Soft
3-1/2" (89 mm)*	56097	0	5/8" (16 mm)	Soft
	56098	0	5/8" (16 mm)	Medium
5" (127 mm)	56100	5	3/8" (10 mm)	Soft
	56104	5	3/8" (10 mm)	Medium
	56176	5	5/8" (16 mm)	Medium
	56186	5	5/8" (16 mm)	Soft
	56241	6	3/8" (10 mm)	Medium
	56274	5	1/2" (13 mm)	Extra Soft
6" (152 mm)	56101	6	3/8" (10 mm)	Soft
	56105	6	3/8" (10 mm)	Medium
	56178	6	5/8" (16 mm)	Medium
	56188	6	5/8" (16 mm)	Soft
8" (203 mm)	56235	5	3/8" (10 mm)	Medium

3"-6" Pads: 13,000 RPM maximum operating speed; 5/16"-24 male thread. (8" dia. pad mounts with 5 screws. 10,000 RPM max.)

\*NOTE: Our 3" (76 mm) and 3-1/2" (89 mm) pads, without holes, can be used for vacuum sanding. Vacuum pick-up is around periphery of pad.

## Exclusive Single-Piece Hub Design

- All Dynabrade Sanding Pads feature our exclusive single-piece hub design, which reduces pad vibration and ensures smooth performance!



- Competitive pads have a hub assembled from three separate pieces, which can contribute to pad "wobbling" and uneven sanding – meaning lost time and lost profits!
- "Face Run-Out" of Dynabrade Pads measures only .002 - .005. Competitive pads measure as high as .015 - .040!

## Channel Vacuum Pads

Pad Diameter	Part Number	Holes	Thickness	Density
5" (127 mm)	56251	5	3/8" (10 mm)	Soft
	56252	5	3/8" (10 mm)	Medium
	56254	5	5/8" (16 mm)	Medium
	56256	5	5/8" (16 mm)	Soft
6" (152 mm)	56261	6	3/8" (10 mm)	Soft
	56262	6	3/8" (10 mm)	Medium
	56264	6	5/8" (16 mm)	Medium
	56266	6	5/8" (16 mm)	Soft

# Hook-Face

# Random Orbital Sanding Pads

## With Dynabrade's Exclusive Single-Piece Hub Design!

- Exclusive single-piece hub design reduces pad vibration and ensures smooth performance.
- PREMIUM URETHANE Sanding Pads are perfectly weight-mated to Dynabrade tools, for achieving consistent **swirl-free finishes**.

Ask for the **ORANGE!**

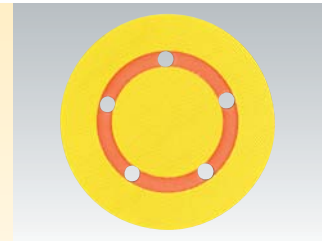
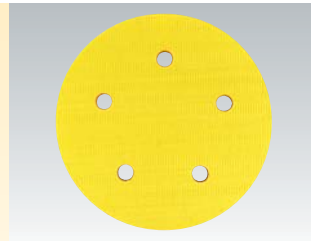
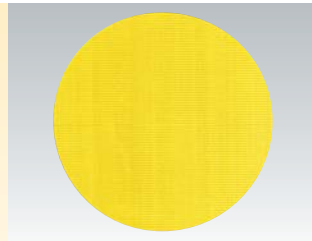
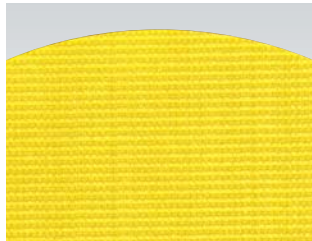

### Hook-Face Pads

Short nap pads for use with reattachable discs.  
Long nap pads for use with non-woven nylon discs.

### Non-Vacuum Pads

High quality backup pad. Weight-mated for smooth running and minimal tool vibration.

### Vacuum Pads

Holes are precisely located to achieve proper alignment with abrasive discs, for optimum vacuum capabilities.

### Channel Vacuum Pads

1/8" (3 mm) deep recessed channel. No need to align abrasive holes with pad holes!

## Non-Vacuum Pads

Pad Diameter	Part Number	Thickness	Nap	Density
3" (76 mm)	56087	5/8" (16 mm)	Short	Medium
	56090	5/8" (16 mm)	Long	Medium
	56145	1/2" (13 mm)	Short	Medium
3-1/2" (89 mm)	54311	5/8" (16 mm)	Short	Soft
	54313	5/8" (16 mm)	Short	Hard
	54314	5/8" (16 mm)	Long	Medium
5" (127 mm)	54325	3/8" (10 mm)	Short	Medium
	56157	3/8" (10 mm)	Short	Soft
	56180	5/8" (16 mm)	Short	Medium
	56195	5/8" (16 mm)	Short	Soft
6" (152 mm)	56271	1/2" (13 mm)	Short	Extra Soft
	54327	3/8" (10 mm)	Short	Medium
	56158	3/8" (10 mm)	Short	Soft
	56182	5/8" (16 mm)	Short	Medium
8" (203 mm)	56197	5/8" (16 mm)	Short	Soft
	56236	3/8" (10 mm)	Short	Medium

3"-6" Pads: 13,000 RPM maximum operating speed; 5/16"-24 male thread. (8" dia. pad mounts with 5 screws. 10,000 RPM max.)

## Channel Vacuum Pads

Pad Diameter	Part Number	Holes	Thickness	Nap	Density
5" (127 mm)	56250	5	3/8" (10 mm)	Short	Medium
	56253	5	3/8" (10 mm)	Short	Soft
	56255	5	5/8" (16 mm)	Short	Medium
	56257	5	5/8" (16 mm)	Short	Soft
6" (152 mm)	56260	6	3/8" (10 mm)	Short	Medium
	56263	6	3/8" (10 mm)	Short	Soft
	56265	6	5/8" (16 mm)	Short	Medium
	56267	6	5/8" (16 mm)	Short	Soft

## Vacuum Pads

Pad Diameter	Part Number	Holes	Thickness	Nap	Density
3" (76 mm)*	56087	0	5/8" (16 mm)	Short	Medium
	56090	0	5/8" (16 mm)	Long	Medium
	56142	6	1/2" (13 mm)	Short	Medium
3-1/2" (89 mm)*	54311	0	5/8" (16 mm)	Short	Soft
	54313	0	5/8" (16 mm)	Short	Hard
	54314	0	5/8" (16 mm)	Long	Medium
5" (127 mm)	54326	5	3/8" (10 mm)	Short	Medium
	56155	5	3/8" (10 mm)	Short	Soft
	56181	5	5/8" (16 mm)	Short	Medium
	56196	5	5/8" (16 mm)	Short	Soft
	56240	6	3/8" (10 mm)	Short	Medium
	56320	44	3/8" (10 mm)	Short	Medium
	56272	5	1/2" (13 mm)	Short	Extra Soft
6" (152 mm)	54328	6	3/8" (10 mm)	Short	Medium
	56156	6	3/8" (10 mm)	Short	Soft
	56183	6	5/8" (16 mm)	Short	Medium
	56198	6	5/8" (16 mm)	Short	Soft
	56321	52	3/8" (10 mm)	Short	Medium
8" (203 mm)	56322	48	3/8" (10 mm)	Short	Medium
	56327	8	3/8" (10 mm)	Short	Medium

3"-6" Pads: 13,000 RPM maximum operating speed; 5/16"-24 male thread. (8" dia. pad mounts with 5 screws. 10,000 RPM max.)

\*NOTE: Our 3" (76 mm) and 3-1/2" (89 mm) pads, without holes, can be used for vacuum sanding. Vacuum pick-up is around periphery of pad.

## 15-Hole Vacuum Pad\*

Pad Diameter	Part Number	Holes	Thickness	Nap	Density
6" (152 mm)	54331	15	5/8" (16 mm)	Short	Medium
	56297	15	3/8" (10 mm)	Short	Medium

\*NOTE: This pad has unique "8+6+1" hole pattern.

It accepts 6" (152 mm) diameter abrasive discs with these hole patterns:

- 6-Hole • 6+1 • 8+1 • 8+6+1 • 21-Hole • Mesh or Multi-Hole



# SPECIALTY RANDOM ORBITAL SANDING PADS

## Mesh Abrasive Pads

### Multi-Hole Patterns are Compatible with Mesh Abrasive Discs

- For use with Random Orbital Sanders; eliminates “pilling” problems.
- For improved dust-free sanding of body fillers and primer.
- 13,000 max. operating speed; medium density; 5/16"-24 male thread.

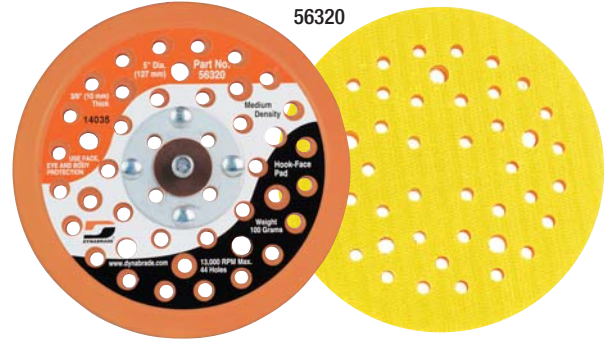

### Vacuum Pads

Pad Diameter	Part Number	Face	Holes	Thickness	Nap
5" (127 mm)	56320	Hook	44	3/8" (10 mm)	Short
6" (152 mm)	56321	Hook	52	3/8" (10 mm)	Short
8" (203 mm)	56322	Hook	48	3/8" (10 mm)	Short
11" (279 mm)	53997	Hook	15	3/8" (10 mm)	Short

### Vacuum and Mesh Conversion Kits

- Transform a Non-Vacuum tool into a Self-Generated Vacuum tool/Mesh Kit.
- Kits include Mesh Abrasive Pad, shroud and conversion parts, bag-in-bag vacuum system, extra disposable vacuum bags and scratch-proof belt strap.

#### Part No. 58055 5" Diameter Kit

- Includes 56320 Pad (5" diameter).

#### Part No. 58060 6" Diameter Kit

- Includes 56321 Pad (6" diameter).



## Radius Edge Pads

### Features Rounded Foam Edge

- For use with Random Orbital Sanders.
- Rounded foam edge of soft density pad conforms to shape of coves and corners.
- Hook-Face attachment is offset from pad edge, allowing abrasive to flex around radius.
- Ideal for use with scalloped-edge abrasives.
- 13,000 maximum operating speed; soft density; 5/16"-24 male thread.



### Non-Vacuum Pads

Pad Diameter	Part Number	Radius Edge	Nap	Thickness
3-1/2" (89 mm)	57796	3/8" (10 mm)	Short	5/8" (16 mm)
5" (127 mm)	57792	3/8" (10 mm)	Medium	5/8" (16 mm)
	57795	3/8" (10 mm)	Short	5/8" (16 mm)

### Vacuum Pad

Pad Diameter	Part Number	Radius Edge	Nap	Holes	Thickness
5" (127 mm)	57799	3/8" (10 mm)	Short	5	5/8" (16 mm)

# ADDITIONAL RANDOM ORBITAL SANDING PADS

## Rubber Random Orbital Sanding Pads

Rubber Sanding Pads for the Economy-Minded Professional

12,000 RPM Maximum Operating Speed • 5/16"-24 Male Thread • Medium Density



### Diamond Pattern

Low-cost alternative to premium urethane pads for the economy-minded professional. Use with PSA-type abrasives.

### Post Pattern

Grooves in bottom of pad allow for enhanced vacuum pick-up. No need to align vacuum holes with abrasive holes. Use with PSA-type abrasives.

### Long Nap Hook-Face

Use with non-woven nylon discs.

### Non-Vacuum Pads

Pad Diameter	Part Number	Face	Nap	Thickness
5" (127 mm)	50630	Diamond	–	1/2" (13 mm)
	50605	Hook	Long	1/2" (13 mm)
6" (152 mm)	50632	Diamond	–	1/2" (13 mm)
	50606	Hook	Long	1/2" (13 mm)

### Vacuum Pads

Pad Diameter	Part Number	Face	Nap	Holes	Thickness
5" (127 mm)	50631	Diamond	–	5	1/2" (13 mm)
	50695	Post Pattern	–	5	1/2" (13 mm)
	50607	Hook	Long	5	1/2" (13 mm)
6" (152 mm)	50633	Diamond	–	6	1/2" (13 mm)
	50696	Post Pattern	–	6	1/2" (13 mm)
	50610	Hook	Long	6	1/2" (13 mm)

## Value Pad

### Quality Sanding Pad

- Vinyl-face.
- Medium density pad for use with Random Orbital Sanders.
- 5/16"-24 male thread.



### Non-Vacuum Pads

Pad Diameter	Part Number	Thickness	Density
5" (127 mm)	56205	3/8" (10 mm)	Medium
6" (152 mm)	56206	3/8" (10 mm)	Medium

### Vacuum Pads

Pad Diameter	Part Number	Holes	Thickness	Density
5" (127 mm)	56207	5	3/8" (10 mm)	Medium
6" (152 mm)	56208	6	3/8" (10 mm)	Medium

## Display Packs

### Display Pads in Refillable Dynabrade Box

- Each display pack consists of ten Dynabrade Random Orbital Sanding Pads.
- Pads fit Dynabrade tools as well as other manufacturers' sanders.



Pad Diameter	Pack Part No.	Pad Part No.	Vacuum Type	Holes
5" (127 mm)	95994	56106	Non-Vacuum	0
	95995	56104	Vacuum	5
6" (152 mm)	95996	56107	Non-Vacuum	0
	95997	56105	Vacuum	6

## Vinyl-Face

# Gear-Driven Sanding Pads

5", 6" and 8" Diameter Pads for Use with Gear-Driven Sanders

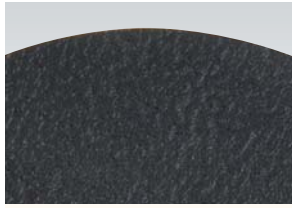

### Vinyl-Face Pads

Ideal for PSA-type disc adhesion. Remove abrasive adhesive paper liner and press abrasive to vinyl-face sanding pad. Quick disc removal.

- 5 screw-mount system for tool models 58441-58446.
- All pads: **PREMIUM URETHANE**; medium density.



### Non-Vacuum Pads



Pad Diameter	Part Number	Max. RPM	Thickness	Screws
5" (127 mm)	57761	12,000	3/8" (10 mm)	5
6" (152 mm)	57762	12,000	3/8" (10 mm)	5
8" (203 mm)	56234	10,000	1/2" (13 mm)	5

### Vacuum Pads



Pad Diameter	Part Number	Max. RPM	Thickness	Holes	Screws
6" (152 mm)	57763	12,000	3/8" (10 mm)	6	5
8" (203 mm)	56235	10,000	1/2" (13 mm)	8	5

## Hook-Face

# Gear-Driven Sanding Pads

5", 6" and 8" Diameter Pads for Use with Gear-Driven Sanders

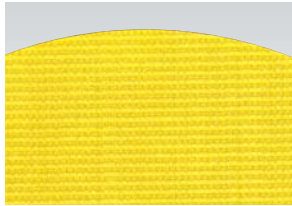

### Hook-Face Pads

Short nap pads for use with reattachable discs.

- 5 screw-mount system for tool models 58441-58446.
- All pads: **PREMIUM URETHANE**; medium density.

### Non-Vacuum Pads



Pad Diameter	Part Number	Max. RPM	Thickness	Screws
5" (127 mm)	57760	12,000	3/8" (10 mm)	5
6" (152 mm)	57387	10,000	3/8" (10 mm)	6
	57764	12,000	3/8" (10 mm)	5
8" (203 mm)	56236	10,000	1/2" (13 mm)	5

### Vacuum Pads

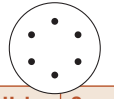

Pad Diameter	Part Number	Max. RPM	Thickness	Holes	Screws
6" (152 mm)	57765	12,000	3/8" (10 mm)	6	5
8" (203 mm)	56237	10,000	1/2" (13 mm)	8	5

### Channel Vacuum Pad



Pad Diameter	Part Number	Max. RPM	Thickness	Holes	Screws
6" (152 mm)	57766	12,000	3/8" (10 mm)	8	5

## Rubber

# Gear-Driven Sanding Pads

- 8" (203 mm) diameters only.
- Rubber pads for the economy-minded professional.
- Hook-Face pads mount with five screws.
- Medium density.



### Non-Vacuum Pads



Pad Diameter	Part Number	Nap	Thickness
8" (203 mm)	54332	Long	1/2" (13 mm)
	54335	Short	1/2" (13 mm)

### Vacuum Pads



Pad Diameter	Part Number	Holes	Nap	Thickness
8" (203 mm)	54333	8	Long	1/2" (13 mm)
	54336	8	Short	1/2" (13 mm)



# 11" Random Orbital & Gear-Driven Sanding Pads

**Premium Foam Pads for Large Diameter Sanders – For use on Both Non-Vacuum and Vacuum Models**

*3,000 RPM Maximum Operating Speed*

*Mounts with Five Screws • Five Holes • Medium Density*

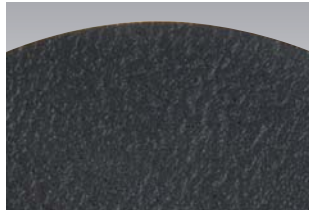

## Vinyl-Face Pads

Ideal for PSA-type disc adhesion. Remove abrasive adhesive paper liner and press abrasive to Vinyl-Face sanding pad. Quick disc removal.

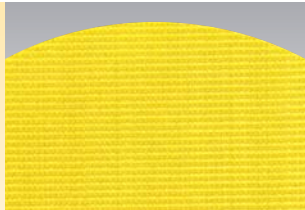

## Hook-Face Pads

Short nap pads for use with reattachable discs.

## Non-Vacuum/Vacuum Pads



Pad Diameter	Part Number	Face	Nap	Thickness
11" (279 mm)	56230	Vinyl	–	1/2" (13 mm)
	56231	Hook	Short	1/2" (13 mm)



# Dynaline Sanding Pads

*3/8" (10 mm) Thick, Medium Density Pads*

• Pads mount with two screws.

## Non-Vacuum Pads

Pad Dimensions	Part Number	Face	Nap	Screws
2-3/4" x 8" (70 mm x 203 mm)	57454	Vinyl	–	2
	57456	Hook	Short	2
	57471	Hook	Long	2
3-2/3" x 7" (93 mm x 178 mm)	57850	Vinyl	–	2
	57851	Hook	Short	2
	57852	Hook	Long	2

## Non-Vacuum Pad with Clips

Pad Dimensions	Part Number	Face	Nap	Screws
2-3/4" x 8" (70 mm x 203 mm)	57460	Vinyl	–	2

## Channel Vacuum Pads

Pad Dimensions	Part Number	Face	Nap	Screws
3-2/3" x 7" (93 mm x 178 mm)	57870	Vinyl	–	4
	57871	Hook	Short	4



## Vacuum Pads

Pad Dimensions	Part Number	Face	Nap	Screws
2-3/4" x 8" (70 mm x 203 mm)	57455	Vinyl	–	6
	57457	Hook	Short	6
3-2/3" x 7" (93 mm x 178 mm)	57855	Vinyl	–	10
	57856	Hook	Short	10

## Contoured Pads

- Vinyl-face, premium urethane, medium density.
- Accepts 2-3/4" (70 mm) wide x 8" (203 mm) long PSA abrasive sheets.

Part Number	Pad Type
57462	Backsplash
57458	"Bull-nose"



# Dynafine® Sanding Pads



## Round Shape

Diameter	Part No.	Vacuum Type	Thickness	Holes	Attachment	Nap	Density	Screws
3" (76 mm)	58044	Vacuum	3/8" (10 mm)	6	Vinyl-Face	–	Soft	2
	58047	Vacuum	3/8" (10 mm)	6	Hook-Face	Short	Soft	2



## Triangular Shape

Diameter	Part No.	Vacuum Type	Thickness	Holes	Attachment	Nap	Density	Screws
2-7/8" x 3-1/8" (73 mm x 79 mm)	57950	Non-Vacuum	3/8" (10 mm)	0	Vinyl-Face	–	Medium	2
	57951	Non-Vacuum	3/8" (10 mm)	0	Hook-Face	Short	Medium	2
	57955	Non-Vacuum	3/8" (10 mm)	0	Hook-Face	Long	Medium	2
	58046	Vacuum	3/8" (10 mm)	6	Vinyl-Face	–	Medium	2
	58049	Vacuum	3/8" (10 mm)	6	Hook-Face	Short	Medium	2

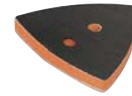

Non-Vacuum



Vacuum

## Tear Drop Shape

Diameter	Part No.	Vacuum Type	Thickness	Holes	Attachment	Nap	Density	Screws
3-3/4" x 2-3/8" (95 mm x 60 mm)	57952	Non-Vacuum	3/8" (10 mm)	0	Vinyl-Face	–	Medium	2
	57953	Non-Vacuum	3/8" (10 mm)	0	Hook-Face	Short	Medium	2
	57954	Non-Vacuum	3/8" (10 mm)	0	Hook-Face	Long	Medium	3
	58045	Vacuum	3/8" (10 mm)	6	Vinyl-Face	–	Medium	2
	58048	Vacuum	3/8" (10 mm)	6	Hook-Face	Short	Medium	2



Non-Vacuum



Vacuum

## Raised Panel Shape

Diameter	Part No.	Vacuum Type	Thickness	Attachment	Nap	Density	Screws
4" x 3/4" (102 mm x 19 mm)	57956	Non-Vacuum	3/8" (10 mm)	Hook-Face	Short	Soft	2
4" x 1-1/4" (102 mm x 32 mm)	57957	Non-Vacuum	3/8" (10 mm)	Hook-Face	Short	Soft	2



**NOTE:** 98293 Complete Raised Panel Pad Assembly includes 57956 pad, mounting plate and two screws.  
57905 Kit includes 57956 pad and eight abrasive strips. 98292 Adapter mounts to tool (no pad included).

# Dynafine® Backsplash Sanding Pads

*Excellent for Fabricating Solid Surface Coved Backsplashes*

- Choose radius pads or reverse radius pads.



## Radius Non-Vacuum Pads

Radius Dimension	Shape	Part Number	Face
1/4" (6 mm)		58020	Vinyl
3/8" (10 mm)		58021	Vinyl
1/2" (13 mm)		58022	Vinyl
5/8" (16 mm)		58023	Vinyl

## Reverse Radius Non-Vacuum Pad

Radius Dimension	Shape	Part Number	Face
3/4" (19 mm)		58024	Vinyl

# Dynabug® “Model T” Pads

• 20,000 RPM maximum operating speed. Pads mount with four screws (except 57999 - mounts with clips).



## Vinyl-Face, Non-Vacuum Pads

Pad Dimensions	Part Number	Thickness	Density
5" (127 mm) Dia.	56246	5/8" (16 mm)	Soft
	56249	3/8" (10 mm)	Medium
6" (152 mm) Dia.	56269	3/8" (10 mm)	Medium
	56287	5/8" (16 mm)	Soft
4" W x 4-5/16" L (102 mm x 110 mm) with Clips	57999	1/4" (6 mm)	Medium
4-1/4" W x 4-1/2" L (108 mm x 114 mm)	56244	3/8" (10 mm)	Medium
	56245	5/8" (16 mm)	Soft

## Vinyl-Face, Vacuum Pads

Pad Dimensions	Part No.	Holes	Thickness	Density
4-1/4" W x 4-1/2" L (108 mm x 114 mm)	56286	6	1/4" (6 mm)	Medium
	56291	6	3/8" (10 mm)	Medium
	56293	6	5/8" (16 mm)	Soft

## Hook-Face, Non-Vacuum Pads

Pad Dimensions	Part Number	Thickness	Density
5" (127 mm) Dia.	56247	5/8" (16 mm)	Soft
	56248	3/8" (10 mm)	Medium
6" (152 mm) Dia.	56268	3/8" (10 mm)	Medium
	56288	5/8" (16 mm)	Soft
4-1/4" W x 4-1/2" L (108 mm x 114 mm)	57996	5/8" (16 mm)	Soft
	57998	3/8" (10 mm)	Medium

## Hook-Face, Vacuum Pads

Pad Dimensions	Part No.	Holes	Thickness	Density
5" (127 mm) Dia.	58086*	5	1/2" (13 mm)	Medium
6" (152 mm) Dia.	58093*	6	1/2" (13 mm)	Medium
4-1/4" W x 4-1/2" L (108 mm x 114 mm)	56292	6	3/8" (10 mm)	Medium
	56294	6	5/8" (16 mm)	Soft
	56285	6	3/16" (5 mm)	Medium

\*For use with Wet Dynabug® “Model T”. Ask for details.

# Dynabug® Sanding Pads

• 3/8" (10 mm) thick, medium density pads. Pads mount with four screws.

## Non-Vacuum Pads

Pad Dimensions	Part Number	Face	Nap	Screws
3-2/3" x 7" (93 mm x 178 mm)	57850	Vinyl	–	4
	57851	Hook	Short	4
	57852	Hook	Long	4

## Vacuum Pads

Pad Dimensions	Part Number	Face	Nap	Screws
3-2/3" x 7" (93 mm x 178 mm)	57855	Vinyl	–	4
	57856	Hook	Short	4



## Channel Vacuum Pads

Pad Dimensions	Part Number	Face	Nap	Screws
3-2/3" x 7" (93 mm x 178 mm)	57870	Vinyl	–	4
	57871	Hook	Short	4

# Dynabug® II Pads

• 3/8" (10 mm) thick, medium density pads. Pads mount with four screws.

## Non-Vacuum Pads

Pad Dimensions	Part Number	Face
2-3/4" x 7" (68 mm x 175 mm)	56354	Vinyl
3" x 4-1/4" (74 mm x 109 mm)	56315	Hook
	56355	Vinyl
3-1/4" x 5" (80 mm x 130 mm)	56317	Hook
	56357	Vinyl
4-1/4" x 4-1/2" (108 mm x 114 mm)	56330	Vinyl
	56331	Hook

## Vacuum Pads



Pad Dimensions	Part Number	Vacuum Holes	Face
2-3/4" x 7-3/4" (68 mm x 196 mm)	56326	8	Hook
3" x 4-1/4" (74 mm x 109 mm)	56316	4	Hook
	56356	4	Vinyl
3-1/4" x 5" (80 mm x 130 mm)	56318	8 (4+4)	Hook
	56319	8	Hook
	56359	8	Vinyl
3-7/8" x 5-5/8" (99 mm x 143 mm)	56323	7 “Delta-Style”	Hook



# Interface Pads and Pad Conversions

## For Combining with Standard Dynabrade Pads for Increased Versatility

### Dynafoam Interface Pads

- Attaches between sanding pad and Hook-Face abrasive.
- Soft foam increases conformability allowing operator to easily follow contours. Converts standard pad into a fine finishing and finessing pad!
- Interface pad easily contours to most surfaces.

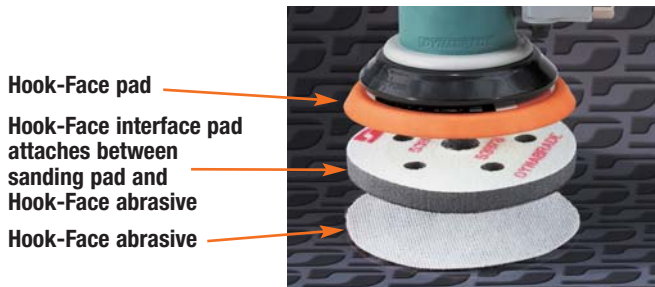

#### For Random Orbital Sanders

Part No.	Diameter	
53974	3" (76 mm)	○
53976	3-1/2" (89 mm)	○
53978	5" (127 mm)	⊙
53980	6" (152 mm)	⊙
53965	6" (152 mm)	⊙
53982	8" (203 mm)	⊙

#### For Dynafine® Detail Sanders

Part No.	Shape	
53970	Tear Drop	◐
53972	Triangle	△

#### For 11" Sanders

Part No.	Diameter	
53998	11"	⊙

#### For Dynaline and Dynabug® Sanders

Part No.	Dimensions	
53984	2-3/4" (70 mm) x 11" (279 mm) For the Dynaline	▭
53986	2-3/4" (70 mm) x 8" (203 mm) For the Dynaline	▭
53988	3-2/3" (93 mm) x 7" (175 mm) For the Dynaline and Dynabug®	▭

### Vinyl-to-Hook Conversions

- Thin sticky-back sheet adheres to current vinyl-face pad and accepts Hook-Face abrasives and Hook-Face interface pads.



#### For Random Orbital Sanders

Part No.	Diameter	
53975	3" (76 mm)	○
53977	3-1/2" (89 mm)	○
53979	5" (127 mm)	⊙
53981	6" (152 mm)	⊙

#### For Dynafine® Detail Sanders

Part No.	Shape	
53971	Tear Drop	◐
53973	Triangle	△

#### For Dynaline and Dynabug® Sanders

Part No.	Dimensions	
53985	2-3/4" (70 mm) x 11" (279 mm) For the Dynaline	▭
53987	2-3/4" (70 mm) x 8" (203 mm) For the Dynaline	▭
53989	3-2/3" (93 mm) x 7" (175 mm) For the Dynaline and Dynabug®	▭

### Hook-to-Vinyl Conversions

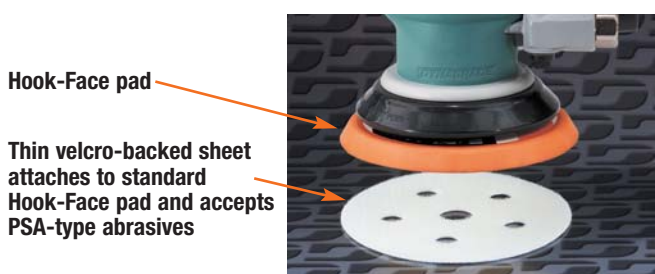

#### Non-Vacuum and Vacuum

Part No.	Diameter	
53992	5" (127 mm)	⊙

Part No.	Diameter	
53993	6" (152 mm)	⊙

# 11" File Board Sanding Pads

3/8" (10 mm) Thick, Medium Density Pads

*Pads Mount with Two Screws*

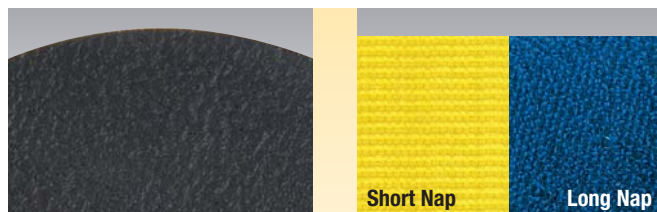

## Vinyl-Face Pads

Ideal for PSA-type adhesion. Press abrasive sheet directly to Vinyl-Face sanding pad. Quick abrasive removal.

## Hook-Face Pads

Short nap pads for use with reattachable sheets.

Long nap pads for use with non-woven nylon sheets.



## Non-Vacuum Pads

Pad Dimensions	Part Number	Face	Nap
2-3/4" x 11" (70 mm x 278 mm)	57511	Vinyl	-
	57513	Hook	Short
	57514	Hook	Long

## Non-Vacuum Pad with Clips

Pad Dimensions	Part Number	Face
2-3/4" x 11" (70 mm x 278 mm)	57512	Vinyl

# Hook-Face Buffing Pads

For Use with Dynabrade Buffing Tools



## Yellow Foam

Cutting - foam cells are larger and further apart than White Foam cells making the action more aggressive.

## White Foam

Polishing - foam cells are smaller and closer together than Yellow Foam cells making the action less aggressive.

## Orange Waffle Foam

Use during compounding stage to remove swirl and haze marks.



## Terry Cloth

Application and removal of waxes and polishes.

## Synthetic Wool

Final finishing and polishing.

## Natural Sheepskin

Final finishing and polishing; softer feel than synthetic wool.

Pad Dimensions	Part No.	Description	Type	Color
3" (76 mm)	90027	Terry Cloth	Polishing	White
	90028	Synthetic Wool	Polishing	White
	90038	Foam Flat	Polishing	White
	90044	Foam Flat	Cutting	Yellow
	90080	Natural Sheepskin	Polishing	White
3-1/4" (83 mm)	90070	Foam Waffle	Polishing	Orange
3-1/2" (89 mm)	90034	Natural Sheepskin	Polishing	Tan
3-3/4" (95 mm)	90071	Foam Waffle	Polishing	Orange
4" (102 mm)	90024	Cotton Buff	Polishing	White
5" (127 mm)	90036	Natural Sheepskin	Polishing	Tan
	90040	Foam Flat	Polishing	White
	90045	Foam Flat	Cutting	Yellow
	90081	Natural Sheepskin	Polishing	White
5-1/4" (133 mm)	90063	Foam Waffle	Polishing	Orange
6" (152 mm)	54330*	Foam Flat	Polishing	Yellow
	90046	Foam Flat	Cutting	Yellow
	90047	Foam Flat	Polishing	White
7" (178 mm)	90082	Natural Sheepskin	Polishing	White
8" (203 mm)	90041	Foam Flat	Polishing	Blue
	90083	Synthetic Wool	Cutting	White

\*NOTE: Part Number 54330 has 5/16"-24 male thread

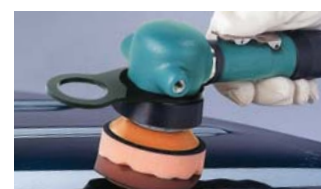

# Foam-Backed Sanding Pads

## Soft Density Sanding Pads



### Foam Backing

Soft, dual density bonded dual action pad for use on curved and contour surfaces.

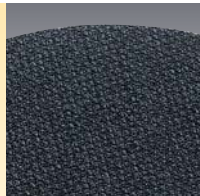

### Hook-Face Pads

Short nap pads for use with reattachable discs.

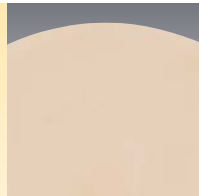

### Rubber-Face

For use with PSA and screen abrasives.

## Non-Vacuum Pads

Pad Diameter	Part Number	MOS (RPM)	Face	Mounts with	Thickness
6" (152 mm)	50828	3,200	Rubber	5/8"-11 Female Thread	1-1/4" (32 mm)
8" (203 mm)	50829	3,200	Rubber	5/8"-11 Female Thread	1-1/4" (32 mm)
	54337	1,500	Hook	5 Screws	1" (25 mm)

**NOTE:** Part Number 54337 is weight-mated to Model 58445 (8" Gear-Driven Orbital Sander)

# Wet/Dry Sander Disc Pads

## Hook-Face Pads



For Use With 4" to 8" Dia. Wet/Dry Sanders



### Rigid Backing

For finishing flat surfaces with non-woven nylon abrasive discs.



### Foam Backing

Soft, dual density bonded dual action pad for use on curved and contour surfaces.



### Urethane

Pads are long tapered with an extremely flexible edge for sanding contours.

## Non-Vacuum Pads

Pad Diameter	Part No.	Type	Nap	MOS RPM	Thread
2" (51 mm)	50156	Rigid	Long	10,000	3/8"-24 Female
4"-5" (102-127 mm)	50146	Rigid	Short	6,000	1/4"-20 Female
	50147	Rigid	Short	6,000	3/8"-24 Female
5" (127 mm)	50155	Rigid	Long	10,000	5/8"-11 Female
	50884	Rigid	Short	10,000	5/8"-11 Female
	57542	Urethane	Short	4,800	M14 x 2
	57544	Urethane	Short	4,800	5/8"-11 Female
6" (152 mm)	50946	Foam	Short	3,200	5/8"-11 Female
	57543	Urethane	Short	4,800	M14 x 2
	57545	Urethane	Short	4,800	5/8"-11 Female
7-1/4" (184 mm)	50853	Foam	Short	3,200	5/8"-11 Female
	50854	Foam	Short	3,200	M14 x 2
8" (203 mm)	50855	Foam	Short	3,200	5 Screws
	50947	Foam	Short	3,200	5/8"-11 Female

# Mini-Dynorbital® Disc Pads

## Rigid, Foam and Soft Urethane Pads



### Rigid and Foam Backing

- 3" (76 mm) dia. pads are compatible with angle-head and palm-style Mini-Dynorbital® sanders; Angle-Head Buffers.
- Hook-face pads accept reattachable abrasive discs as well as polishing buff pads.

### Soft Urethane

- 3-1/2" (89 mm) pads have loop-facing to mount to rigid backing pads (P/N 50125 and P/N 50126).



**Rigid Backing**  
20,000 RPM Max.

Part No.	Thread Size
50125	1/4"-20 Female
50126	3/8"-24 Female



**Foam Backing**  
5,000 RPM Max.

Part No.	Thread Size
50120	1/4"-20 Female
50122	3/8"-24 Female



**Soft Urethane**  
5,000 RPM Max.

Part No.	Face
54486	Vinyl
54488	Hook



# Air Supply Hose Recommendations

Air Motor SCFM (Standard Cubic Feet Per Minute)	Hose & Fitting I.D. Required	Recommended Length Air Supply Hose
22 SCFM (623 L/Min)	1/4" (8 mm)	1' - 8' (0.3048 m - 2.44 m)
28 SCFM (793 L/Min)	3/8" (10 mm)	1' - 25' (0.3048 m - 7.6 m)
35 SCFM (991 L/Min)	3/8" (10 mm)	1' - 20' (0.3048 m - 6.10 m)
45 SCFM (1,274 L/Min)	3/8" (10 mm)	1' - 10' (0.3048 m - 3.042 m)
73 SCFM (2,067 L/Min)	1/2" (15 mm)	1' - 20' (0.3048 m - 6.10 m)



## Random Orbital Sander Swirl-Free Checklist

### Equipment Check:

#### Random Orbital Sander

- 90 PSIG (6.2 Bar) is the required operating air supply pressure.** Check the air pressure at the sander while it is running. Note: Promote the use of Dynabrade maximum flow plugs and couplers to ensure proper airflow.
- Confirm that the tool is running at the rated "Free Speed" RPM.** On an average a 10,000 RPM non-vacuum sander will run at 9,500 RPM; a 12,000 RPM non-vacuum sander will run at 11,500 RPM. A vacuum sander normally runs slightly slower.
- Inspect the balancer bearing (pad bearing).** Remove the back-up pad and rotate the balancer bearing shaft while holding the counterbalance stationary. The balancer shaft should turn freely.



#### Back-Up Pad

- Inspect the face of the sanding pad.** The pad must be flat and smooth, without any defects. Check if they are using a Dynabrade back-up pad that is "weight-mated" to the sander. Using another pad can make the sander vibrate excessively and lead to an unacceptable finish.

### Sanding Techniques:

- Always START the sander ON the surface, and STOP the sander OFF the surface.**
- When sanding keep the sander, and pad FLAT on the surface.** **Important:** Do not exert heavy downward force on the sander. Apply enough downward force to keep the back-up pad and abrasive flat on the surface allowing the back-up pad to orbit freely over the surface.

### Sanding Techniques (Continued)

- Follow a set pattern when sanding.** It is suggested to pass over the surface following a "North, South, East, West" pattern (see below), overlapping each pass 1/4 the diameter of the back-up pad and abrasive. This insures that the previous scratches are removed and that a uniform finish is achieved. Two "patterns" per sanding step are recommended.

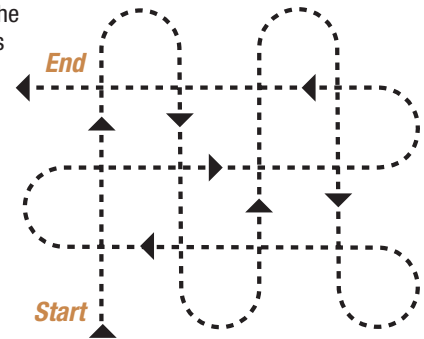

- Frequently inspect abrasive for tears, folds, or build-up.** When changing abrasive to proceed to the next sanding step, first inspect the condition of the abrasive that is on the sander. If any defects are noticed in that abrasive, remove it and install another piece of the same grain and sand the work surface again before proceeding on to the next sanding step.
- Always clear away sanding dust and abrasive debris before progressing to the next sanding step with a finer "grit" abrasive.**

## The Cost Of An Air Hose Leak

### One 1/16" hole in a hose leaks at 100 PSIG:

- 4.25 cubic feet per minute (CFM)
- 255 cubic feet per hour
- 2,040 cubic feet in an 8-hour day
- 6,120 cubic feet per 24 hours

### The cost of one leaking air hose:

$$\begin{array}{rcl}
 240 & \times & 6,120 & = & 1,468,800 \\
 \text{working days} & & \text{leakage in cf} & & \text{air lost in cf} \\
 \text{per year} & & \text{per 24 hours} & & \text{per year} \\
 \\ 
 1,468,800 & \times & \$0.00041^* & = & \$602.21^* \\
 \text{air lost in cf} & & \text{cost per cf based on typical} & & \text{total cost} \\
 \text{per year} & & \text{energy costs per kilowatt-hour} & & \text{per year!}
 \end{array}$$

\*Costs will vary based on local charges per kilowatt-hour.

## Plug Connectors

### Compare Airflow SCFM (L/Min)

- All information based upon size of I.D. at 90 PSIG (6.2 Bar) in conjunction with mating coupler.
- NPT (National Pipe Thread) is the thread size (such as 1/4" NPT).

#### Common Plug Connector 25 SCFM (708 L/Min)



#### Dynabrade Plug Connector 76 SCFM (2,152 L/Min)



Inside  
Diameter

Thread  
Size (NPT)

# How Easy is it to do Business with your Air Tool Company?

**Service, Quality and Commitment - that's the Dynabrade Difference**



- **Technical Salesmen Around the World**
- **Same-Day or Next-Day USA Shipping**
- **FREE On-Site Demonstrations**
- **LIFETIME WARRANTY on Air Tools**

**Check Out Why Dynabrade Is the Global Leader in Random Orbital Sanding**



### **Comfort Platform**

**USA Patent No. D610,428**  
Provides additional hand and wrist support.



### **Auto-Recess Throttle Lever**

Lever recesses into housing when depressed, eliminating pressure point on operator's palm.



### **Compact Grip Size**

Compact, vibration-absorbing grip is ideal for operators with smaller hands.



### **Steel Cylinder & End Plates**

Steel cylinder and end plates stay perfectly aligned. Design of end plates keeps more air in cylinder, increasing motor efficiency!



### **Low Sound Levels**

Muffling system reduces sound levels to as low as 76 dB(A). Threaded muffler cap stays tight as tool runs!



### **Perfectly Balanced Sanding Pad**

**Ask for the ORANGE!**  
Perfectly balanced, weight-mated sanding pad with exclusive **single-piece hub design!**



69020 Dynorbital®  
Silver Supreme

**In the USA,  
Call 1-800-828-7333 for Free  
Demonstration and Literature!**

**DYNABRADE.COM**



# Discover The Dynabrade Difference!



*Since 1969, Dynabrade has  
Achieved a Leadership Role in the Design  
and Manufacture of Unique Portable Abrasive Power Tools!*



**For More Tools and Related Accessories, Visit: [Dynabrade.com](http://Dynabrade.com)**



#### **DYNABRADE, INC.**

8989 Sheridan Drive • Clarence, New York 14031-1419  
Phone: 716-631-0100 • US Fax: 716-631-2073 • International Fax: 716-631-2524  
**US Consumers Call Toll-Free: 1-800-828-7333**  
**Canadian Consumers Call Toll-Free: 1-800-344-1488**

#### **DYNABRADE EUROPE S.à r.l.**

Zone Artisanale Op Tomm 6 • L-5485 Wormeldange-Haut, Luxembourg  
Phone: +352 768 494 1 • Fax: +352 768 495

#### **DYNABRADE INDIA ABRASIVE POWER TOOLS Pvt Ltd.**

EL-54, TTC Industrial Area, M.I.D.C. Mahape • Electronic Zone, Navi Mumbai - 400705  
Maharashtra, India • Phone: +91 22 2763 2226 • Fax: +91 22 2763 2228

**US Consumer Toll-Free Number: 1-888-DYNABRADE**

DISTRIBUTED BY: